

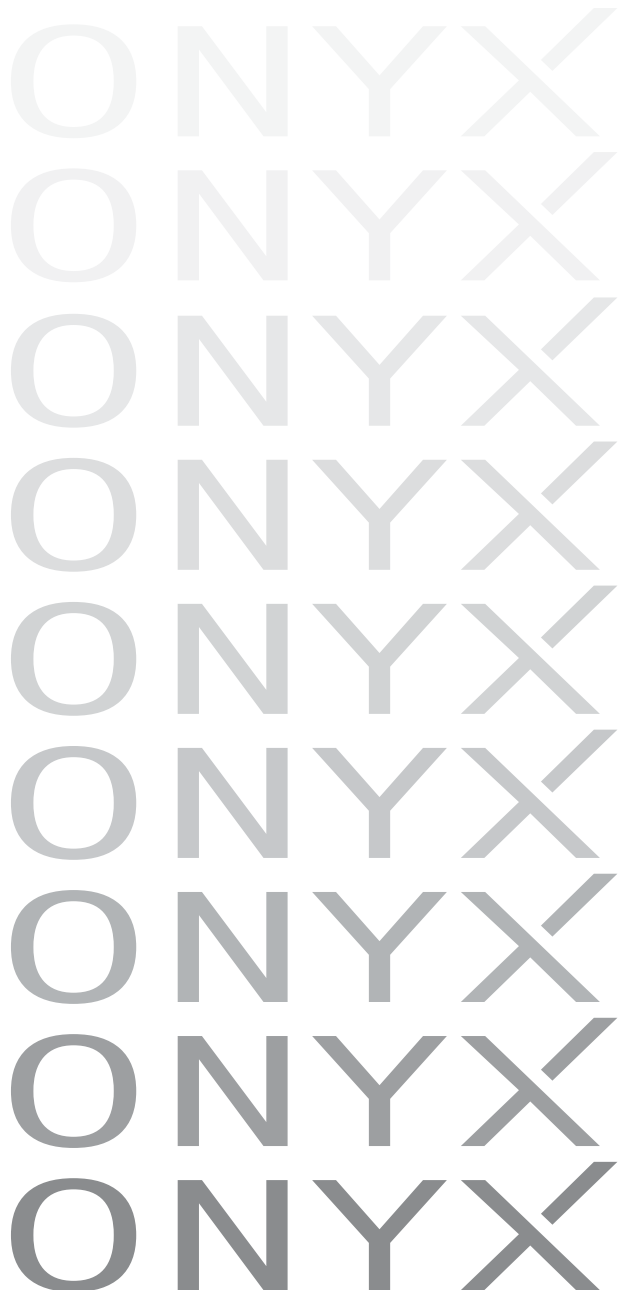

ONYX·Satellite

PORTABLE RECORDING PREAMP
with 96kHz FIREWIRE INTERFACE

OWNER'S MANUAL



Important Safety Instructions

1. Read these instructions.
2. Keep these instructions.
3. Heed all warnings.
4. Follow all instructions.
5. Do not use this apparatus near water.
6. Clean only with dry cloth.
7. Do not block any ventilation openings. Install in accordance with the manufacturer's instructions.
8. Do not install near any heat sources such as radiators, heat registers, stoves, or other apparatus (including amplifiers) that produce heat.
9. Do not defeat the safety purpose of the polarized or grounding-type plug. A polarized plug has two blades with one wider than the other. A grounding-type plug has two blades and a third grounding prong. The wide blade or the third prong are provided for your safety. If the provided plug does not fit into your outlet, consult an electrician for replacement of the obsolete outlet.
10. Protect the power cord from being walked on or pinched particularly at plugs, convenience receptacles, and the point where they exit from the apparatus.
11. Only use attachments/accessories specified by the manufacturer.
12. Use only with a cart, stand, tripod, bracket, or table specified by the manufacturer, or sold with the apparatus. When a cart is used, use caution when moving the cart/apparatus combination to avoid injury from tip-over.

13. Unplug this apparatus during lightning storms or when unused for long periods of time.
14. Refer all servicing to qualified service personnel. Servicing is required when the apparatus has been damaged in any way, such as power-supply cord or plug is damaged, liquid has been spilled or objects have fallen into the apparatus, the apparatus has been exposed to rain or moisture, does not operate normally, or has been dropped.
15. This apparatus shall not be exposed to dripping or splashing, and no object filled with liquids, such as vases, shall be placed on the apparatus.
16. This apparatus does not exceed the Class A/Class B (whichever is applicable) limits for radio noise emissions from digital apparatus as set out in the radio interference regulations of the Canadian Department of Communications.

ATTENTION — *Le présent appareil numérique n'émet pas de bruits radioélectriques dépassant les limites applicables aux appareils numériques de class A/de class B (selon le cas) prescrites dans le règlement sur le brouillage radioélectrique édicté par les ministere des communications du Canada.*

17. Exposure to extremely high noise levels may cause permanent hearing loss. Individuals vary considerably in susceptibility to noise-induced hearing loss, but nearly everyone will lose some hearing if exposed to sufficiently intense noise for a period of time. The U.S. Government's Occupational Safety and Health Administration (OSHA) has specified the permissible noise level exposures shown in the following chart.

According to OSHA, any exposure in excess of these permissible limits could result in some hearing loss. To ensure against potentially dangerous exposure to high sound pressure levels, it is recommended that all persons exposed to equipment capable of producing high sound pressure levels use hearing protectors while the equipment is in operation. Ear plugs or protectors in the ear canals or over the ears must be worn when operating the equipment in order to prevent permanent hearing loss if exposure is in excess of the limits set forth here.

PORTABLE CART WARNING



Carts and stands - The Component should be used only with a cart or stand that is recommended by the manufacturer. A Component and cart combination should be moved with care. Quick stops, excessive force, and uneven surfaces may cause the Component and cart combination to overturn.



CAUTION AVIS

RISK OF ELECTRIC SHOCK
DO NOT OPEN
RISQUE DE CHOC ELECTRIQUE
NE PAS OUVRIR

CAUTION: TO REDUCE THE RISK OF ELECTRIC SHOCK DO NOT REMOVE COVER (OR BACK) NO USER-SERVICEABLE PARTS INSIDE REFER SERVICING TO QUALIFIED PERSONNEL
ATTENTION: POUR EVITER LES RISQUES DE CHOC ELECTRIQUE, NE PAS ENLEVER LE COUVERCLE. AUCUN ENTRETIEN DE PIECES INTERIEURES PAR L'USAGER. CONFIER L'ENTRETIEN AU PERSONNEL QUALIFIE.
AVIS: POUR EVITER LES RISQUES D'INCENDIE OU D'ELECTROCUTION, N'EXPOSEZ PAS CET ARTICLE A LA PLUIE OU A L'HUMIDITE



The lightning flash with arrowhead symbol within an equilateral triangle is intended to alert the user to the presence of uninsulated "dangerous voltage" within the product's enclosure, that may be of sufficient magnitude to constitute a risk of electric shock to persons.
Le symbole éclair avec point de flèche à l'intérieur d'un triangle équilatéral est utilisé pour alerter l'utilisateur de la présence à l'intérieur du coffret de "voltage dangereux" non isolé d'ampleur suffisante pour constituer un risque d'électrocution.



The exclamation point within an equilateral triangle is intended to alert the user of the presence of important operating and maintenance (servicing) instructions in the literature accompanying the appliance.
Le point d'exclamation à l'intérieur d'un triangle équilatéral est employé pour alerter les utilisateurs de la présence d'instructions importantes pour le fonctionnement et l'entretien (service) dans le livret d'instruction accompagnant l'appareil.

Duration Per Day In Hours	Sound Level dBA, Slow Response	Typical Example
8	90	Duo in small club
6	92	
4	95	Subway Train
3	97	
2	100	Very loud classical music
1.5	102	
1	105	Tami screaming at Adrian about deadlines
0.5	110	
0.25 or less	115	Loudest parts at a rock concert

WARNING — To reduce the risk of fire or electric shock, do not expose this apparatus to rain or moisture.

Table of Contents

Introduction.....	5
Onyx Satellite Features	6
Getting Started	7
Computer Requirements	7
Installing the Windows Drivers	7
Macintosh OS X Audio MIDI Setup.....	7
Installing Tracktion 2	8
Zero the Controls	10
Connections.....	10
Set the Levels	11
Set the Sample Rate and Latency	11
Start Recording to DAW.....	12
Hookup Diagrams	13
Onyx Satellite Features.....	17
Pod Front Panel.....	17
1. Channel GAIN.....	17
2. Signal Level Indicators	17
3. Instrument Switch.....	17
4. POWER Indicator	17
5. FireWire Indicator	18
6. 48V Phantom Power Switch and Indicator	18
7. CTRL RM/PHONES 1 Level.....	18
8. PHONES 2 Level	18
9. PHONES 1 and 2 Outputs.....	18
Pod Rear Panel	19
10. MIC/Line Inputs	19
11. CR OUT	19
12. TO DOCK Connector.....	19
13. FIREWIRE	19
14. POWER Connector	19
15. Kensington Security Slot	19
Base Station Front Panel	20
16. MIC Input Select Switch	20
17. Instrument Input Select Switch.....	20

Don't forget to visit our website at www.mackie.com for more information about this and other Mackie products.



18. Line Input 1 Select Switch20

19. Line Input 2 Select Switch20

20. Built-in Talkback Mic21

21. TALKBACK LEVEL Control21

22. TO PHONES Switch.....21

23. TO DAW Switch.....21

24. CONTROL ROOM LEVEL Control.....21

25. SOURCE Select Switch21

26. A/B Select Switch22

27. 1-2/1-6 Select Switch.....22

28. Power Switch22

29. Base Station Dock22

Base Station Rear Panel.....23

30. MIC Input23

31. LINE 1 Input23

32. LINE 2 Input.....23

33. Instrument Input23

34. INSERT Jacks23

35. OUTPUTS 3-624

36. CR OUT 1 and 2.....24

37. FIREWIRE24

38. POWER Connector.....24

39. Kensington Security Slot.....24

Appendix A: Service Information..... 25

 Warranty Service 25

 Troubleshooting..... 25

 Repair 26

Appendix B: Connections 27

Appendix C: Technical Info 30

 Onyx Satellite Specifications 30

 Onyx Satellite Dimensions 31

 Onyx Satellite Block Diagram 32

Onyx Satellite Limited Warranty 35

Please write your serial number here for future reference (i.e., insurance claims, tech support, return authorization, etc.)

Purchased at:

Date of purchase:

Introduction

Thank you for choosing the Mackie Onyx Satellite professional audio interface for studio and mobile digital audio recording. The Onyx Series computer audio interfaces are designed for the digital era and offer the newest features and latest technologies for digital studio recording in a durable, road-worthy package.

The Onyx Satellite is equipped with two of our new premium precision-engineered studio-grade Onyx mic preamps. Mackie is renowned for the high-quality mic preamps used in our mixers, and the Onyx mic pre's are better than ever, with specifications rivaling other stand-alone boutique mic preamplifiers at twice the price.

The Onyx Satellite is designed to be a transparent audio interface for direct tracking and mixdown, using high performance 24-bit/96 kHz converters to provide wide dynamic range and low noise. It works with virtually any ASIO/Core Audio compliant DAW software application on a PC or Mac as a 2x6 audio interface.

The unique docking feature allows you to set up the Onyx Satellite in your studio, and leave it connected to multiple mic, line, and instrument sources and studio monitors, while “undocking” the portable pod to use on location. This gives you the freedom to take the pod into the field for overdubbing projects or live recordings without having to constantly patch and unpatch the cables that are connected to the base station.

The pod features a Neutrik™ Combo input connector on channels 1-2, which allows you to use either a 1/4" TRS connector or an XLR connector. A global 48V switch applies phantom power to both XLR input connectors.

Channels 1 and 2 also feature an instrument select switch, which lets you connect an acoustic, electric, or bass guitar directly to the 1/4" input, eliminating the need for an external direct box. The pod also has a stereo control room output and two stereo headphone jacks, each with separate level controls (the Control Room and Phones 1 outputs share a level control), and a FireWire connector to connect to your laptop.

When the pod is “docked” to the base station, it gains additional features and expanded input and output capabilities. The base station has a separate XLR connector, two 1/4" TRS line-input connectors, and a 1/4" TS instrument connector for each channel (channels 1-2), with select switches for each input source. Insert jacks are also provided for channels 1-2 to send and return the signal to an external processor. These are pre-ADC (Analog-to-Digital Converters) so they work great for compressors and other dynamic processors.

Six channels of analog balanced line outputs are provided on 1/4" TRS connectors. Two of these can be used as stereo control room outputs, with an A/B switch to route the signal to two separate pairs of monitors for comparison. The built-in talkback microphone can be routed to the phones/control room output or to the DAW for slating. A FireWire connector provides a simple connection to a laptop or desktop computer and allows the audio to be streamed to and from your software of choice.

Both units can be powered either directly from the FireWire bus (when using a six-pin FireWire connector), or from the 12V DC power supply included in the box.

As a bonus, Traktion 2 is included with your Onyx Satellite, our full-featured music production software application for easy recording, mixing, and mastering on a PC or Mac.

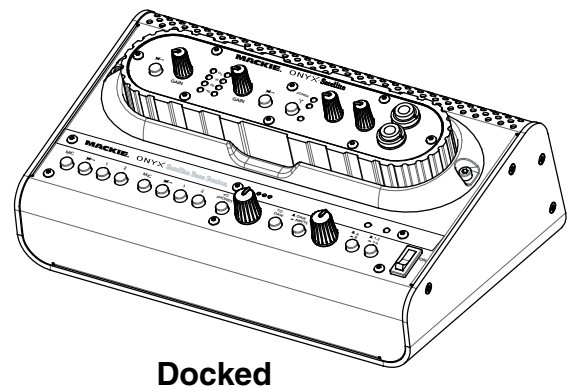
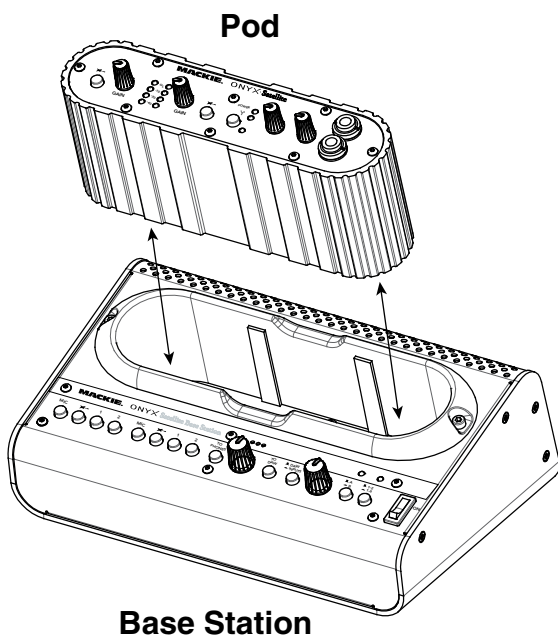

HOW TO USE THIS MANUAL

We know that many of you can't wait to get your new Onyx Satellite computer interface hooked up, and you're probably not going to read the manual first (sigh!). So the first section after this introduction is a Quick-Start Guide called "Getting Started" to help you get the Onyx Satellite set up fast so you can start using it right away. Right after that are the ever popular hook-up diagrams that show typical setups for various recording applications.

Then, when you have time, read the Features Description section. This describes every knob, button, and connection point on the Onyx Satellite.

Throughout this section you'll find illustrations with each feature numbered. If you want to know more about a feature, simply locate it on the appropriate illustration, notice the number attached to it, and find that number in the nearby paragraphs.



This icon marks information that is critically important or unique to the Onyx Satellite. For your own good, read them and remember them. They will be on the final test.



This icon leads you to in-depth explanations of features and practical tips. While not mandatory, they usually have some valuable nugget of information.

A PLUG FOR THE CONNECTOR SECTION

Appendix B is a section on connectors: XLR connectors, balanced connectors, unbalanced connectors, and the insert connectors used on the Onyx Satellite.

More resources on our website at www.mackie.com.

THE FAQs

Click on Support to find answers to many of your questions. The FAQ (Frequently Asked Questions) section is filled with answers to many of the questions our Technical Support staff has fielded over the years.

THE FORUMS

Visit our forums to seek help from our online community of Mackie users.

THE GLOSSARY: A Haven of Non-Techiness for the Neophyte

The "Glossary of Terms" is a fairly comprehensive dictionary of pro-audio terms. If terms like "clipping," "noise floor," or "unbalanced" leave you blank, refer to this glossary for a quick explanation.

ARCANE MYSTERIES ILLUMINATED

"Arcane Mysteries" discusses some of the down 'n' dirty practical realities of microphones, fixed installations, grounding, and balanced versus unbalanced lines. It's a goldmine for the neophyte, and even the seasoned pro might learn a thing or two.

Onyx Satellite Features

- Innovative 2-piece FireWire Recording System for professional recording on a PC or Mac
- Dual Onyx mic preamps for superior sound quality versus competing interfaces
- 8 inputs for connection of microphones, line sources, and instruments
- 6 line-level outputs
- 24-bit/96 kHz capable sound quality
- Built-in control room functions include talkback and A/B monitor switching
- 6-channel volume control allows for surround sound mixing
- Firewire protocol for low latency real-time recording
- Satellite pod can be bus powered for field use or externally powered, for added convenience
- Works with all ASIO and Core Audio compatible software, Mac and PC (also compatible with GigaSampler GSIF drivers)
- Pod provides 2 in/2 out audio streams; "Docked" pod and base station provide 2 in/6 out audio streams
- Bundled with full version of Tracktion 2 software for a complete recording solution on a PC or Mac
- Indestructo Mackie construction holds up to the rigors of field recording

Getting Started

READ THIS PAGE!!

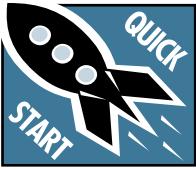

Even if you're one of those people who never reads manuals, all we ask is that you read these next few pages (through page 12) now before you begin using the Onyx Satellite. You'll be glad you did!

If you are using the Onyx Satellite with a PC running Windows XP®, you need to install the Windows drivers first. The Macintosh doesn't require any additional drivers, but you will still want to install Tracttion 2. Refer to page 8 for instructions on installing Tracttion 2 (page 10 for installing on a Mac).

Computer Requirements

These are the minimum computer requirements for using the Onyx Satellite and installing Tracttion 2:

For the PC:

- Microsoft Windows XP SP2
- Pentium 4, Celeron, or Athlon XP processor
- 256 MB RAM

For the Mac:

- OS X 10.3.9
- G4 processor
- 256 MB RAM

It is important to note that the processor speed, amount of RAM installed, and the size and speed of your hard drive all contribute to the overall performance of your recording system.

Installing the Windows Drivers

When connecting the Onyx Satellite to a PC, it is necessary to first install the Onyx FireWire Windows drivers and Satellite Control Panel.

Important: DO NOT connect the Onyx Satellite to your PC until you are instructed to do so during the installation procedure.

1. Insert the CD provided with the Onyx Satellite into your CD drive.
2. The installation process should start automatically. If it doesn't, click "Start > Run > Browse" and navigate to the CD drive. Double-click the file named: "DoubleClickToInstall.exe."
3. Click "OK" in the Run window.

4. You may get a "Security Warning" about running the installer. It's okay. Click "Run."



5. Follow the instructions for the rest of the installation procedure. When it is completed, your Onyx Satellite is ready to use. The POWER and FireWire indicators on the Satellite should both be lit.
6. The Onyx Satellite should now appear as a 2x6 audio interface available for any ASIO DAW (or Gigasampler) application that you have installed on your computer.

Note: It is still necessary to select the Onyx Satellite as the audio device in the DAW software application's "Settings" window.

Macintosh OS X Audio MIDI Setup

The Macintosh OS X has its own built-in system level audio drivers, so you don't need to install any additional drivers or a separate control panel to use the Onyx Satellite with a Macintosh.

OS X has a dedicated setup utility for audio and MIDI. You can use the Audio Setup utility to change the default audio input and output and general system settings on your Macintosh.

1. Connect the Onyx Satellite to your Macintosh using the supplied FireWire cable.
2. Go to the Applications folder and open the Utilities folder.

3. Double-click “Audio MIDI Setup.”

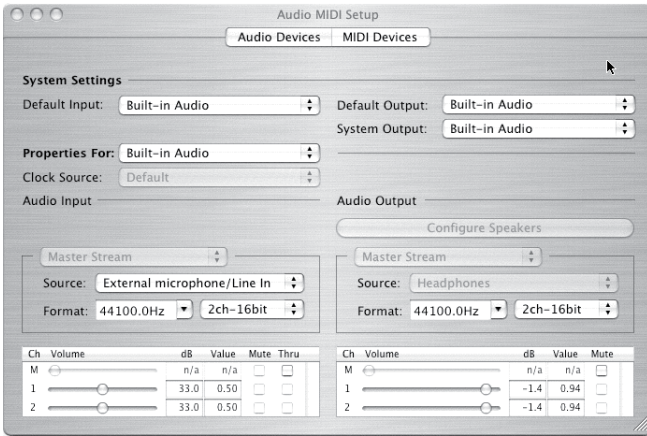

4. Click the Audio Devices tab, and select Onyx Satellite in the “Properties For” drop-down box.

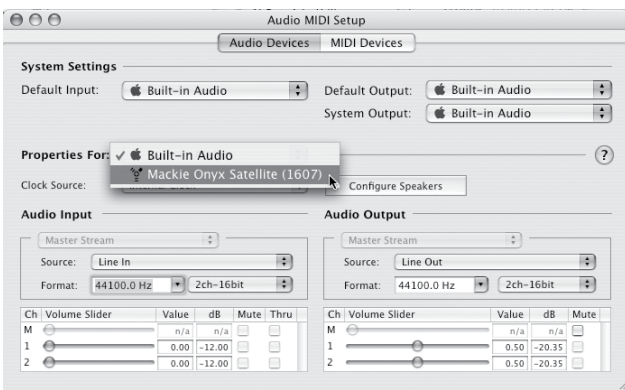

5. Here you can see the settings for the Onyx Satellite. You can also choose to use the Onyx Satellite as your default input or output, as well as designate it to be used for system sound output.

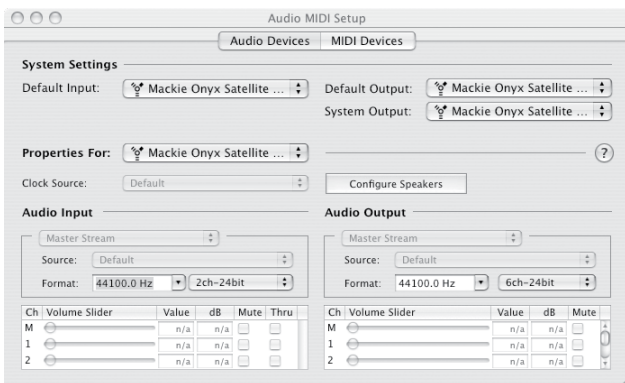

6. You’re ready to go with any Mac OS X Core Audio host application (i.e., Tracktion, Logic, Cubase, Nuendo, Live, Digital Performer, etc.).

The Onyx Satellite should now appear as a 2x6 audio interface available for any DAW application that you have installed on your computer.

Note: It is still necessary to select the Onyx Satellite as the audio device in the DAW software application’s “Settings” window.

Installing Tracktion 2

The CD-ROM that came with your Onyx Satellite also has the full version of Tracktion 2, our easy-to-use multitrack recording and sequencing software for the PC and Mac.

Note: After installing Tracktion 2, be sure to check our website periodically for software updates (www.mackie.com).

To install Tracktion 2 on a PC running Windows XP:

1. Insert the CD-ROM into the CD-ROM drive.
2. Browse to the CD directory and open the “Tracktion 2” folder. You can copy the folder called “Tracktion 2 Documentation” to your hard drive if you like, to make it easier to access.
3. Double-click the file “TracktionSetup.exe”.
4. You may get a “Security Warning” about running the installer. It’s okay. Click “Run.”



5. The next window allows you to select the language you want to use with Tracktion 2 (English, French, German, or Spanish). Make your choice and click “OK.”

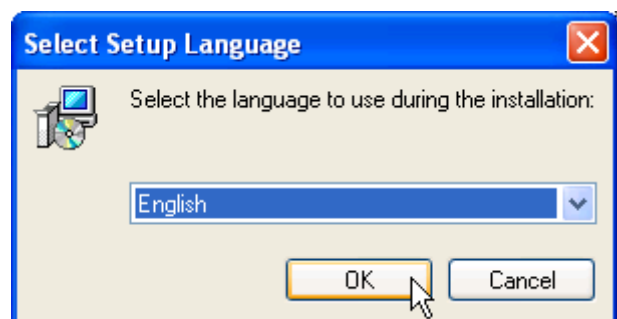

- The Tracktion Setup Wizard opens. Click "Next" to continue.

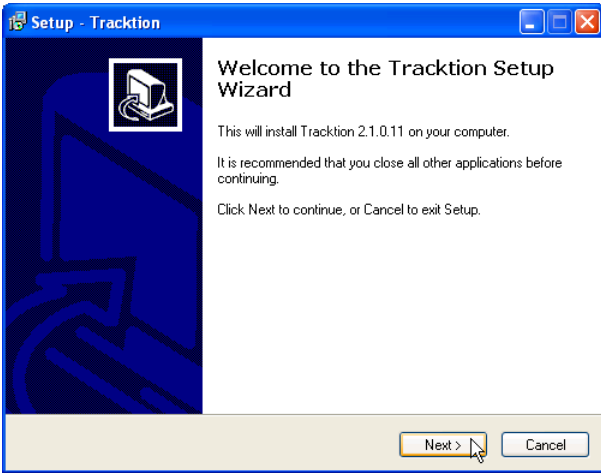

- Next you will see the Tracktion License Agreement. Read through the text and click "I accept the agreement." Click "Next" to continue.

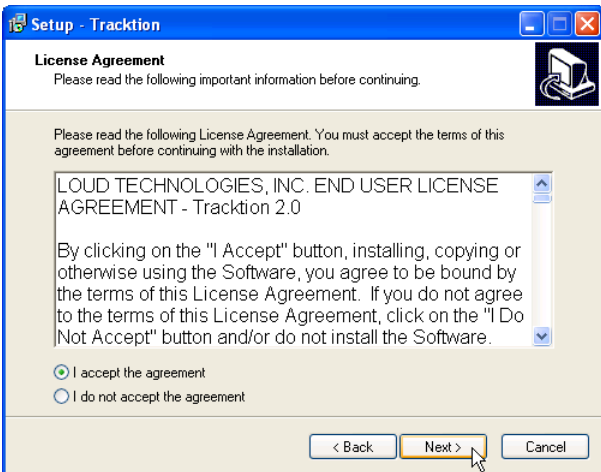

- The next window lets you choose the Destination folder for installing the software files. We recommend you use the default location used by the installer, but you can choose a different location if you want by clicking the Browse button. Then click "Next."

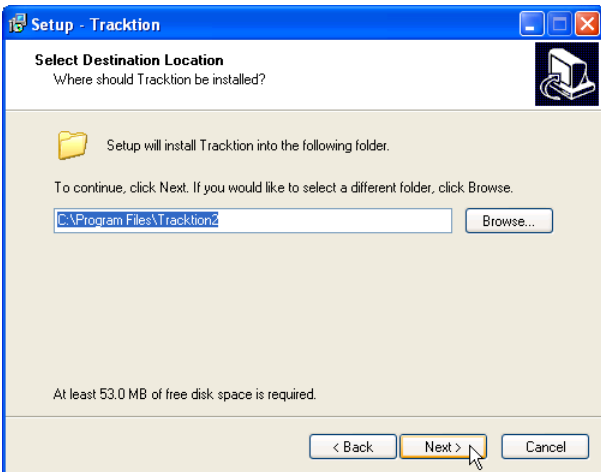

- Next you are asked to select the Start Menu Folder where you would like the Tracktion shortcuts installed. We recommend you use the default location used by the installer, but you can choose a different location if you want by clicking the Browse button. Then click "Next."

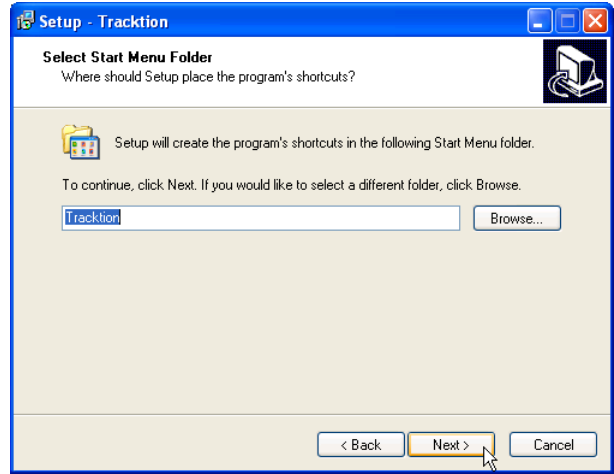

- The next window gives you the options of creating a desktop icon and creating a Quick Launch icon. Select the additional icons you would like to install, and click "Next" to continue.

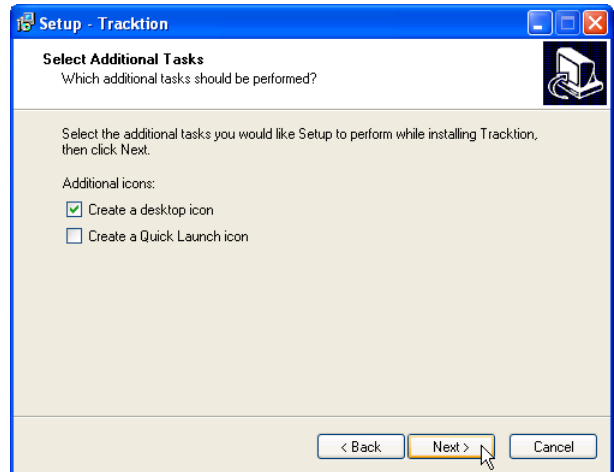

- The next window gives you a summary of the installation options you have selected. Click "Back" if you want to make any changes. Click "Install" to proceed with the installation.

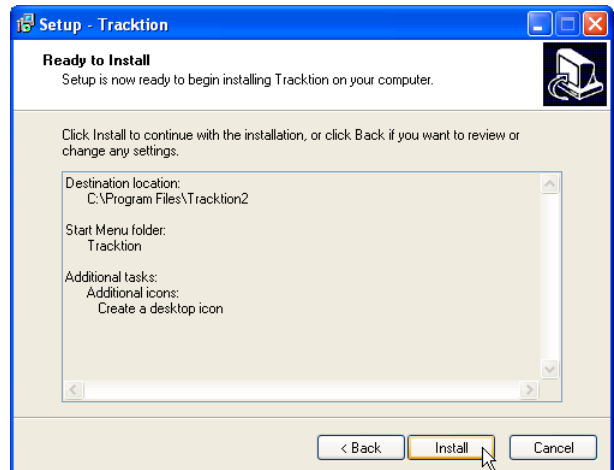

- When the installer has completed copying the files into the destination folder, the “Completing the Tracktion Setup Wizard” window opens. If you want to launch Tracktion right away, click the “Launch Tracktion” box. Click “Finish” to complete the installation.

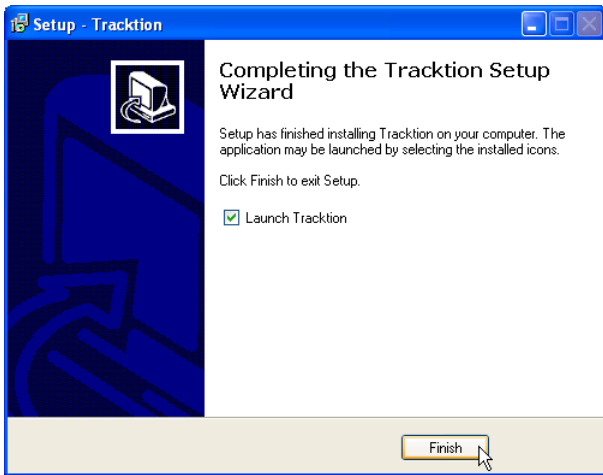

- Double-click the Tracktion.exe file in the destination folder to open Tracktion. (If you selected the option during the installation, you can double-click the Tracktion shortcut icon on your desktop.)

To install Tracktion 2 on a Mac running OS X (version 10.3.9 or later):

- Insert the CD-ROM into the CD-ROM drive.
- Double-click the CD icon on the desktop and double-click the file named “TracktionSetup.dmg”.
- A Tracktion window opens. Drag the Tracktion icon from the Tracktion window into the Applications folder.

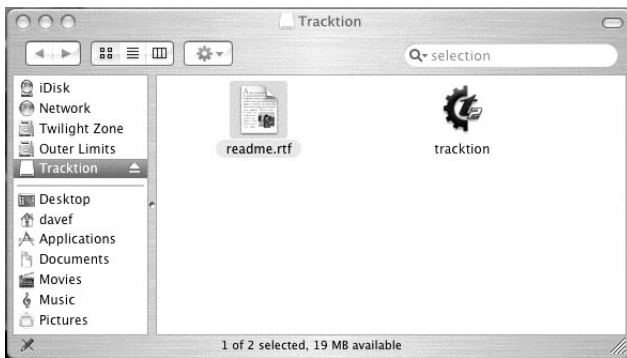

- Double-click the Tracktion file in the Applications folder to open Tracktion.

Authorizing Tracktion 2

There is an authorization code on the sleeve of the CD-ROM that came with your Onyx Satellite. You can authorize the software from within Tracktion or by going to <http://my.mackie.com>.

From Tracktion 2:

- Open Tracktion 2.
- Tracktion detects that the software is unregistered and notifies you that it is running in Demo Mode. You can choose to continue or click the “Unlock” button to authorize the software.
- Follow the instructions for unlocking Tracktion.

From my.mackie.com:

- Go to <http://my.mackie.com>
- If you haven’t done so already, set up an account by entering your email address and clicking “No, I want to create an account.” Then click “Continue.”
- Enter the information to setup your profile. Then proceed to register Tracktion by clicking “Mackie Product Registration.”
- Select “Software” and “Tracktion v2 Music Production Software.”
- Click “Click here to register Tracktion v2 online.”
- Enter the authorization code from the sleeve on your CD-ROM in the License Number box. Then click “Authorize.”

Once you’ve installed and authorized the software, proceed as follows:

Zero the Controls

- Turn down the channel GAIN controls, and the Control Room and Phones level controls.
- Set all push button switches to their “out” positions.
- Turn the POWER switch off.

Connections

Note: This tutorial assumes that you are using the Onyx Satellite with the pod “docked” to the base station.

This demonstrates how to record guitar to your DAW for tracking, and then record a vocal while monitoring the guitar track already laid down:

- Plug a guitar into channel 1 Instrument input and a microphone into channel 2 MIC input. Push in the Instrument switch on channel 1.

2. Connect the FireWire connector from the Onyx Satellite to the FireWire connector on your computer.
3. If you are using the AC adapter with your Onyx Satellite, turn on the Power switch.



Note: The Onyx Satellite is equipped with a 6-pin FireWire connector and comes with a 6-pin to 6-pin FireWire cable. If your computer has a 4-pin FireWire connector, you can use the 6-pin to 4-pin FireWire adapter included in the box to make the connection, but the Onyx Satellite cannot be powered from the 4-pin connector (the two missing pins carry the power). You will need to use the AC adapter included with the Onyx Satellite.

4. If the microphone is a dynamic microphone, leave the 48V switch out. If it is a condenser microphone, push in the 48V phantom power button to turn on the phantom power (applied to XLR inputs 1 and 2).
5. Connect the Control Room A outputs to a pair of powered studio monitors (or to an amplifier connected to a pair of monitors). Optionally, you can connect a pair of headphones to one of the PHONES jack on the pod to monitor the audio.

Set the Levels

To set the channel GAIN controls (on channels 1-2), it's not even necessary to hear what you're doing in the monitors. The following steps must be performed one channel at a time.

1. Play something into the selected input, either guitar (channel 1) or vocal (channel 2). Be sure that the volume of the input source is the same as it would be during normal use. If it isn't, you might have to readjust these levels later.
2. Adjust the channel's GAIN control so that the “-20” and “-10” LEDs light frequently or continuously, and the “0L” LED doesn't light at all (or only flashes occasionally).
3. Repeat for each channel.
4. You can also monitor the input level with the input metering of your DAW software application.

Set the Sample Rate and Latency

On a PC:

1. Open the Onyx Satellite Control Panel (click Start > Programs > Mackie Satellite > Satellite Console). Select the sample rate of your choice (44.1, 48, 88.2, or 96 kHz) and the latency setting.

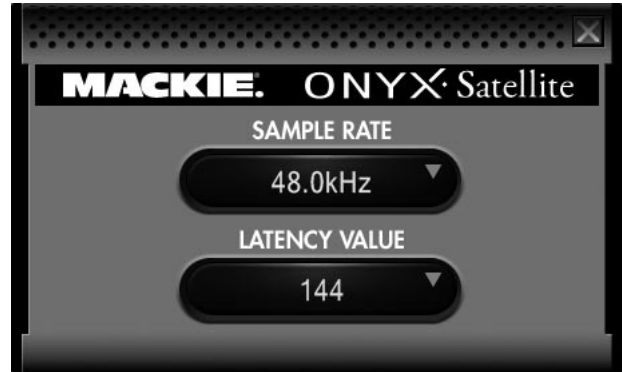

These values should be reflected in your DAW software application, and it is important that they match. If you are using Traktion 2, click the “Settings” tab and then click “Audio Devices” to see the sample rate and latency settings.

On a Mac:

1. Go to the Applications folder and open the Utilities folder.
2. Double-click “Audio MIDI Setup.”

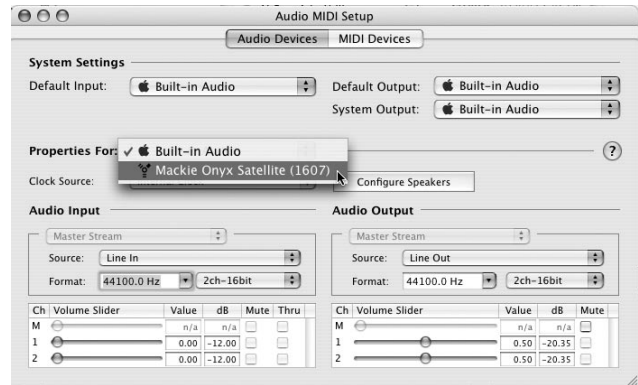

3. Click the Audio Devices tab and select Onyx FireWire in the “Properties For” drop-down box.
4. You can change the sample rate setting in the Format drop-down box. There is no latency setting here. That setting is made in the DAW software application.



Latency (sometimes called buffer size) describes the amount of time it takes for audio to get in and out of your software application. The lower the latency setting, the faster audio can get into and out of the software

application; in other words, the closer to zero delay you will experience while recording. However, a low latency setting requires more resources from your computer, so you need to find a happy balance between finding the lowest latency you can attain before the computer begins to have trouble routing and recording audio (e.g., dropouts, pops, distorted audio).

Many DAW software applications have an ASIO control panel. In Traktion 2, it is located in the “Audio” window under the “Settings” tab. Click the “Show ASIO control panel” button (PC only) to open the ASIO control panel for the Onyx Satellite. The latency setting in the ASIO control panel should be the same as the latency selected in the software application.

Start Recording to DAW

1. Select the Onyx Satellite as the sound device in your DAW application. Each DAW application has its own method of doing this, so refer to your DAW application’s manual if you are not sure. In Traktion 2, this is done in the “Audio” window under the “Settings” tab.
2. Assign the inputs from the Onyx Satellite to tracks in your DAW.
3. You should now see the signals from the Onyx Satellite appearing on the meters in your DAW. Start recording the guitar onto a track in the DAW.
4. Playback the recorded audio and assign the DAW outputs to the Control Room Outputs (1 and 2) on the Onyx Satellite.
5. Listen to the guitar playback on the headphones while recording the vocal part. Make sure the Control Room Source Select switch on the Satellite is out (DAW).
6. You can continue adding tracks to the arrangement, and listen back over the Control Room monitors (or headphones) when you are done.

Other Nuggets of Wisdom

- You can connect the analog outputs from any line-level source to the LINE INPUTS on the Onyx Satellite and use its high-quality analog-to-digital converters to get your analog signals to your digital recorder(s).
- When the Pod is docked, the CTRL RM/PHONES 1 knob on the Pod adjusts only the Phones 1 output (not the Control Room outputs). The CONTROL ROOM LEVEL knob on the Base Station adjusts the Control Room outputs. Use this control as close to the MAX (fully clockwise) position as possible to experience the best audio quality. Turn down the input sensitivity control on your active monitors or your passive monitors’ power amplifier in order to turn up the CONTROL ROOM LEVEL knob as far as possible.
- Always turn off the Onyx Satellite before removing or connecting the Pod to the Base Station.
- When you shut down your equipment, turn off the amplifiers first. When powering up, turn on the amplifiers last.
- Never listen to loud music for prolonged periods. Please see the Safety Instructions on page 2 for information on hearing protection.
- Save the shipping box! You may need it someday, and you don’t want to have to pay for another one.

That’s it for the “Getting Started” section. Next comes the “Hookup” section that shows you some typical ways that you might use the Onyx Satellite in real applications. After that, you can take the grand tour of the Onyx Satellite, with descriptions of every knob, button, input, and output. We encourage you to take the time to read all of the feature descriptions, but at least you know it’s there if you have any questions.

Hookup Diagrams

Home Studio Recording

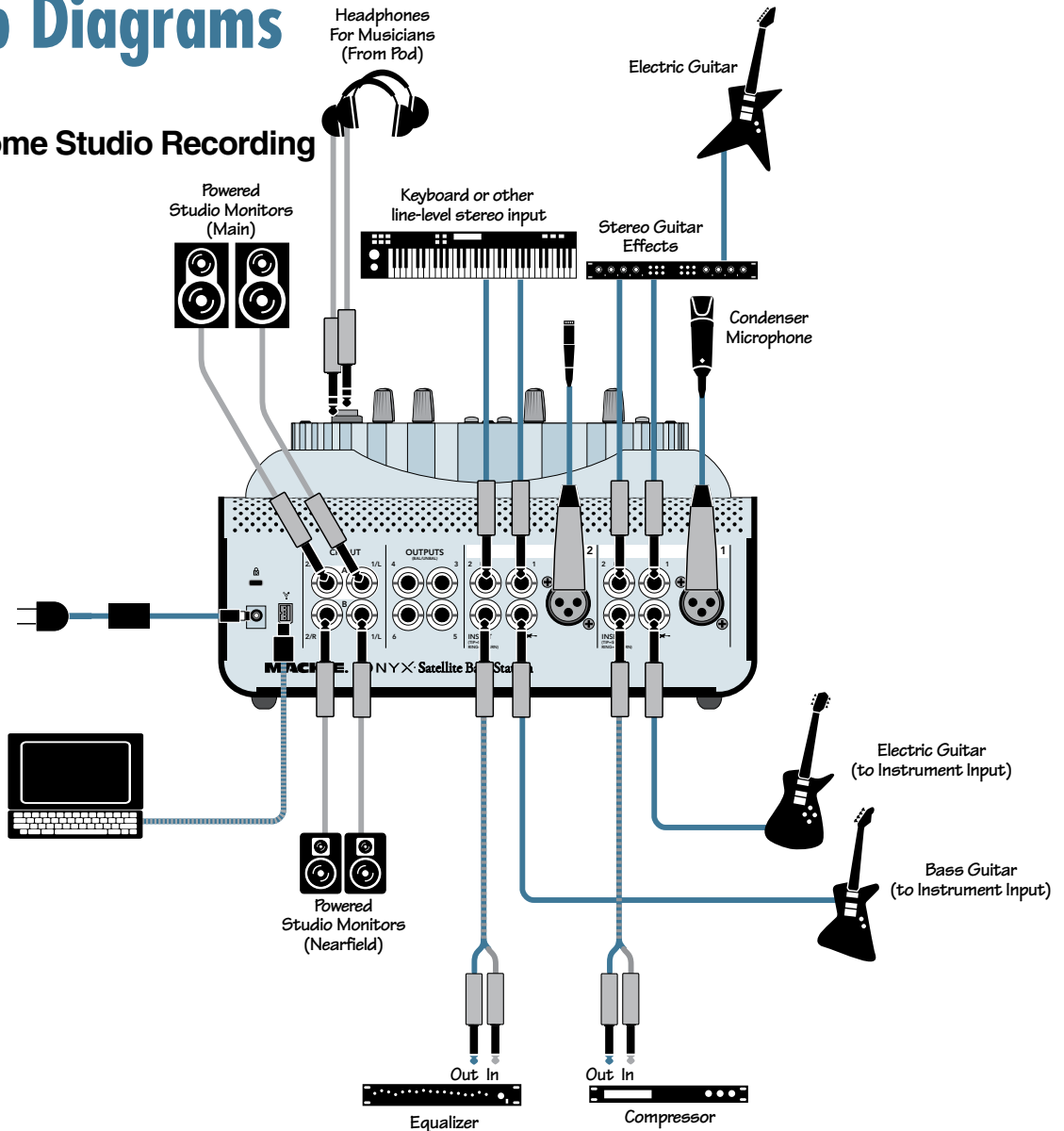

Remote Recording

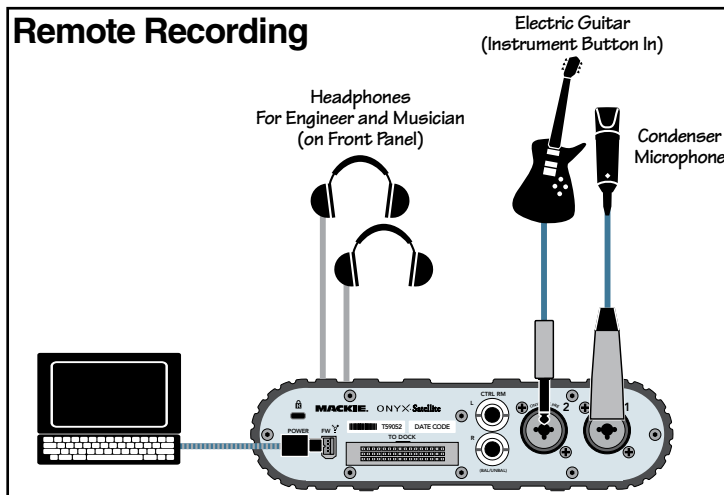

This example demonstrates how the Satellite can be set up in a home studio application with multiple input sources connected to the base station along with two sets of monitors and a laptop connected to the FireWire connection on the Satellite.

The Satellite Pod can then be removed and taken to a second location for overdubbing additional vocal and guitar tracks, leaving all the connections to the base station intact.

Typical Home Studio Setup/Pod Remote Location Recording

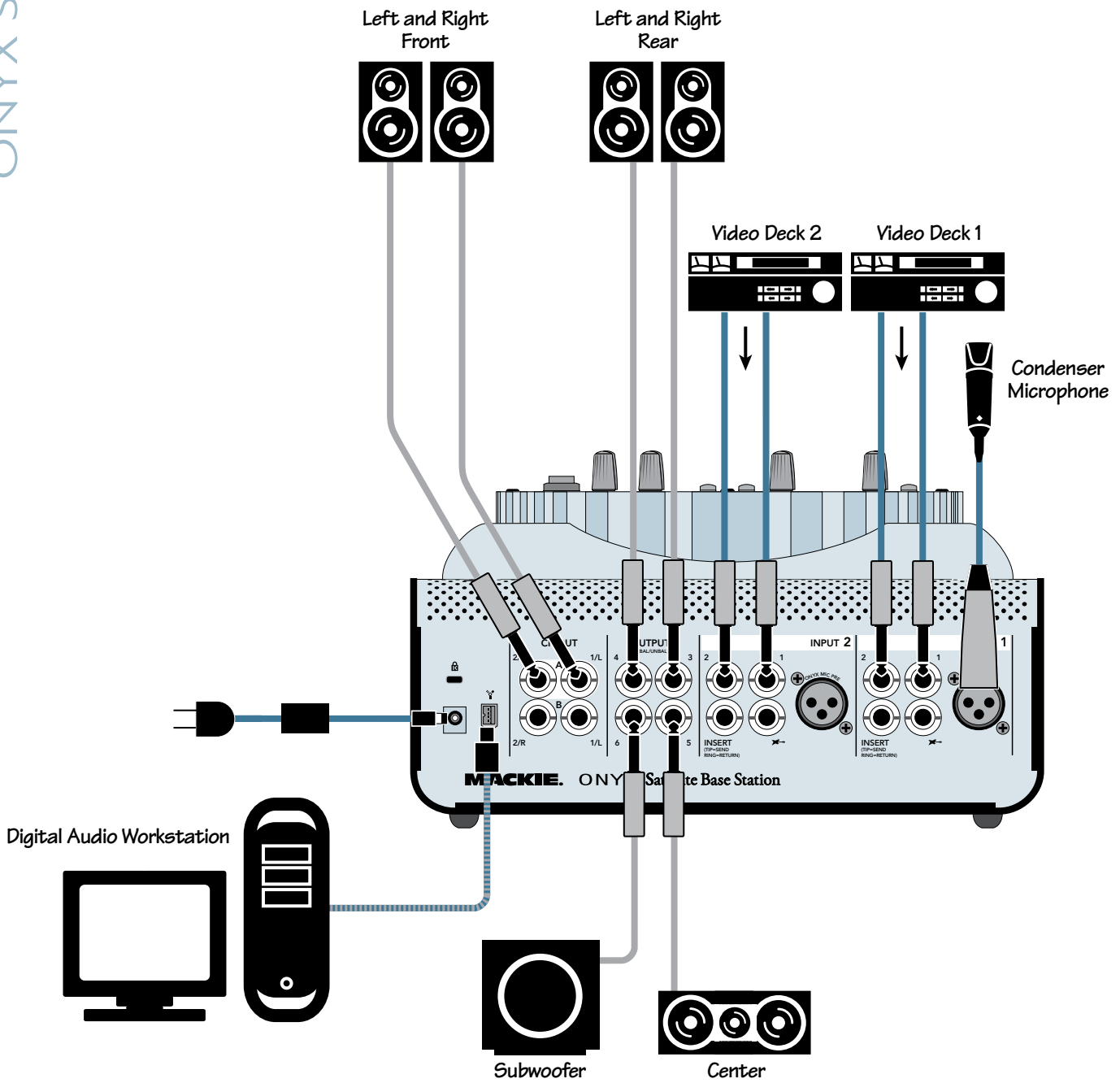

This illustrates a 5.1 surround sound setup using two video decks connected to Line 1 and 2 on Inputs 1 and 2. A microphone is connected to the mic input on Input 1 for voiceover.

Onyx Satellite: Post-Production and Surround Mixing

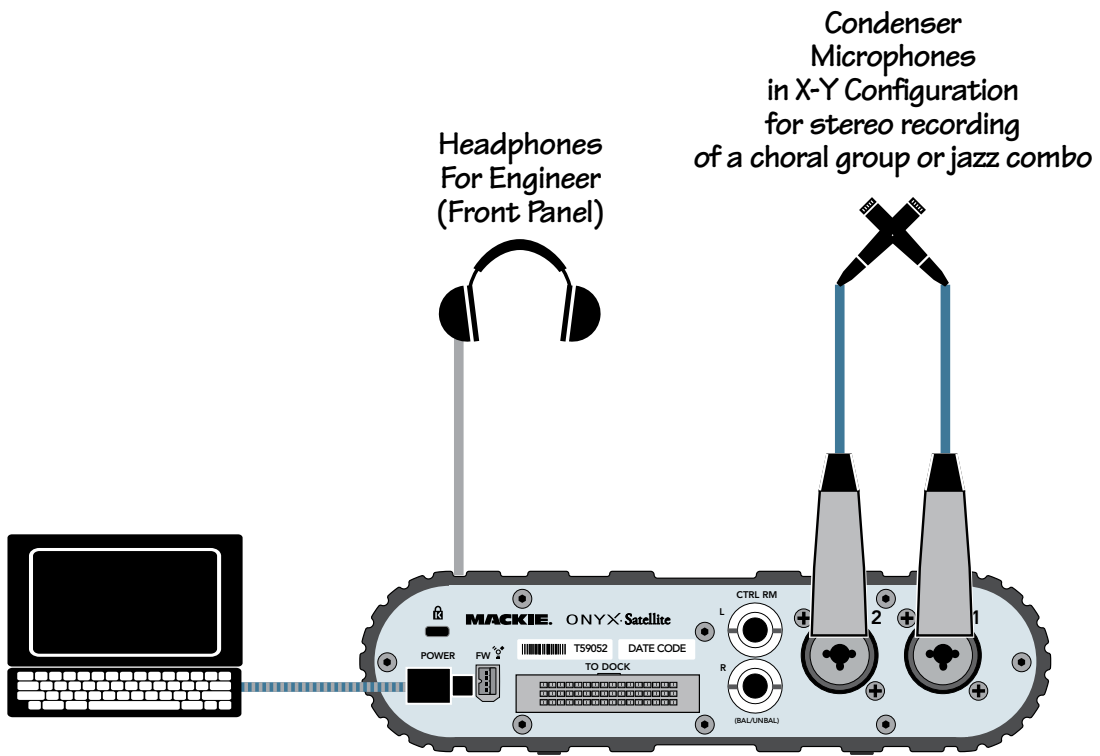

This illustrates how to use the Satellite Pod to make a live stereo recording using an X-Y microphone placement. The recording is made to two tracks in the DAW software on the laptop.

Afterward, you can plug the pod into the base station and play back the recording through monitors connected to the Control Room outputs.

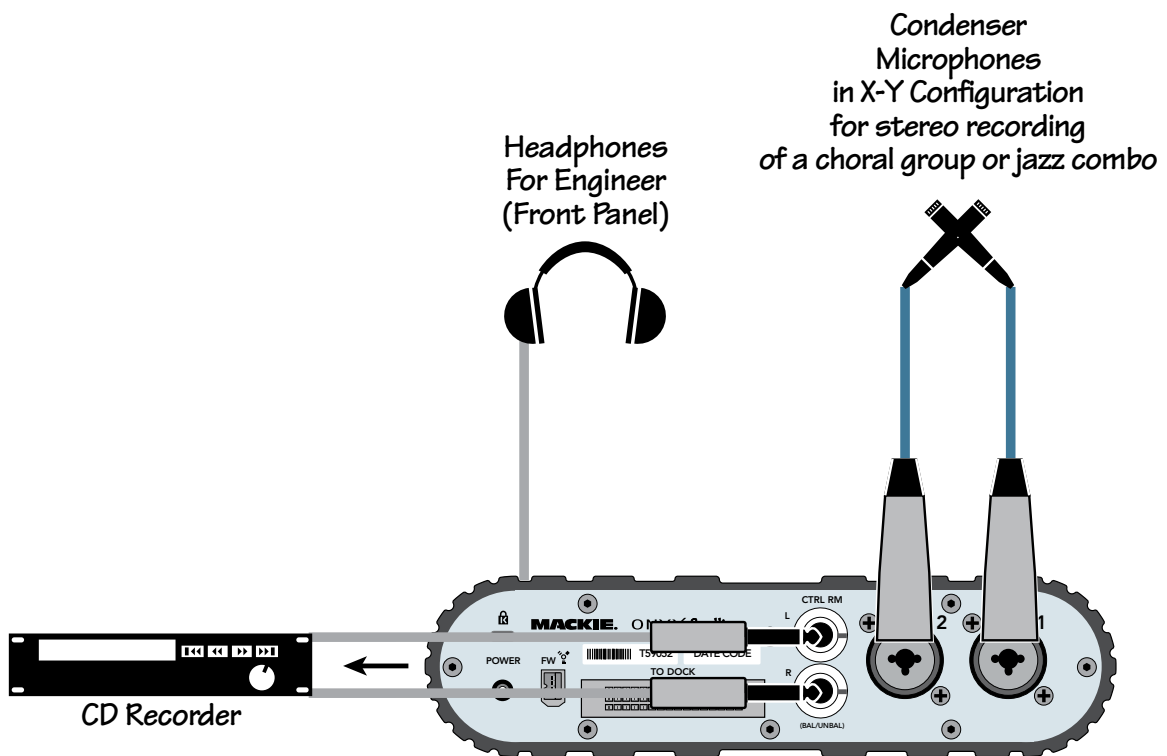

Same scenario as above, but using the Pod in standalone mode without a computer. The Control Room outputs are connected to the inputs of a CD recorder or other recording device to make a stereo recording in the field.

Onyx Satellite Pod Remote Direct-to-2 Track Recording

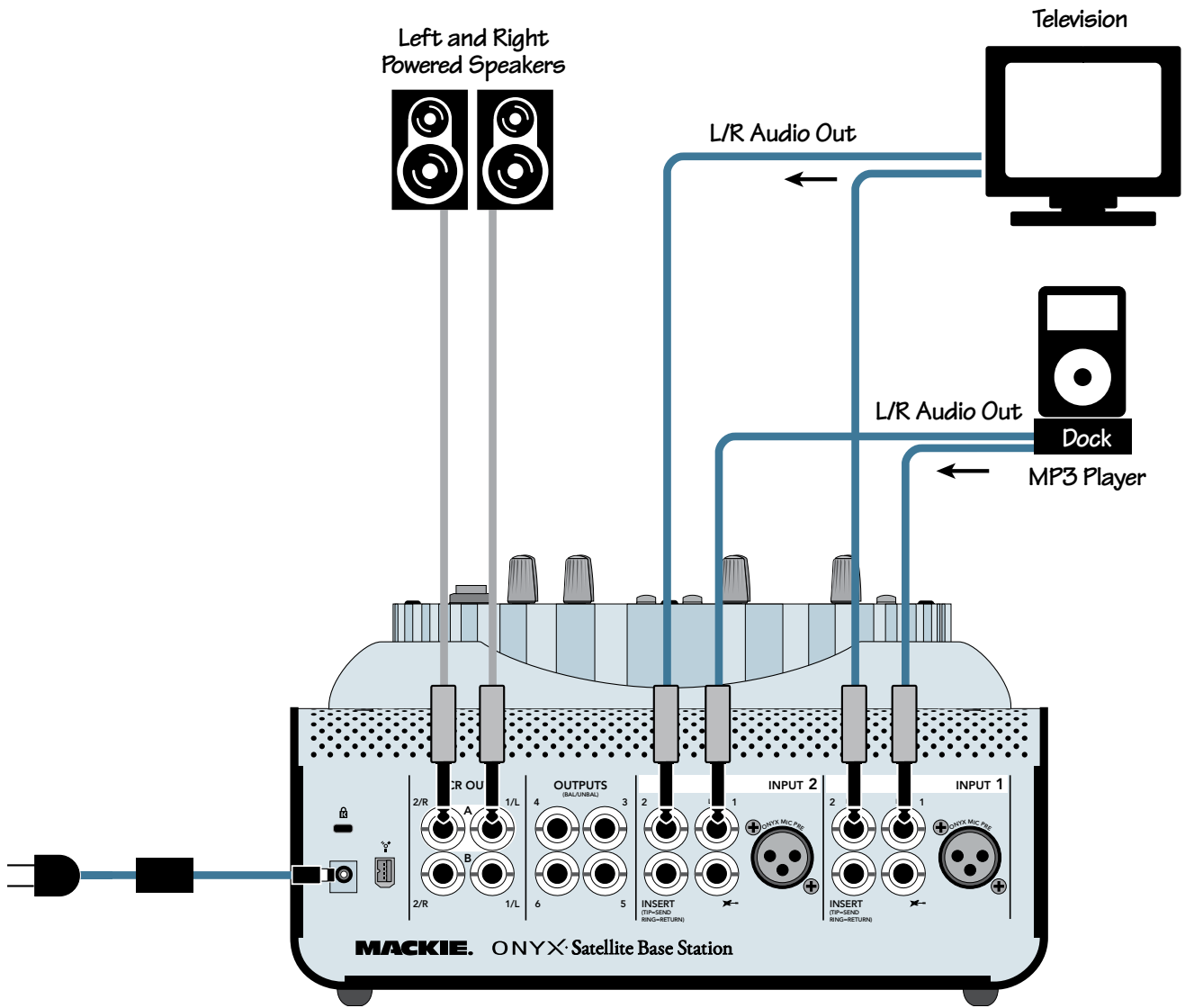

For some just starting out with their own home studio, it may be necessary to use the home stereo speakers for monitors. But what happens when the engineer in the family is off somewhere with his laptop? The Satellite can be used as a preamp for a living room or bedroom stereo system. No laptop required! Simply connect the signal sources (i.e., the outputs from an MP3 player or the stereo audio output from your television tuner) to the Satellite inputs, and connect the Control Room outputs to a pair of powered speakers (or to the inputs of an amplifier with speakers connected). Push in the Control Room Source button (Inputs) and the selected inputs are routed to the Control Room outputs. Use the Control Room knob to adjust the volume.

Onyx Satellite As Stereo Preamp

Onyx Satellite Features

Pod Front Panel

The Onyx Satellite is uniquely designed to be set up in your studio with all the inputs and outputs connected, and allows you to remove the pod from the base station for portable use in the field.

The pod provides two Neutrik combination Mic/Line inputs with independent Gain controls, a global 48V phantom power switch, stereo line-level control room outputs, two stereo headphone jacks with independent level controls (one shared with the control room outputs), and a FireWire connector. Each input channel also has an instrument switch that converts the 1/4" line input into a high-impedance instrument input so you can connect electric instruments directly to the Onyx Satellite without a direct box.

1. Channel GAIN

The GAIN controls adjust the input sensitivity of the mic and line inputs on channels 1-2. This allows the signal from the outside world to be adjusted to optimal internal operating levels.

If a mic-level signal is plugged into the XLR combo jack, there is 0 dB of gain (unity gain) with the knob turned all the way down, ramping up to 60 dB of gain fully up.

When using the balanced line input of the combo jack (1/4" TRS connector), there is 20 dB of attenuation all the way down, and 40 dB of gain fully up, with a "U" (unity gain) mark at about 10:00.

2. Signal Level Indicators

These LEDs indicate the channel's signal level after the GAIN control and just after the analog-to-digital converter.

If you've followed the "Set the Levels" procedure on page 11, the -20 and -10 LEDs should light frequently, and the OL (Overload) LED should not light at all. If the OL LED is blinking frequently, the signal is probably distorted from overdriving the input. Either turn down the GAIN control or turn down the signal at its source.

3. Instrument Switch

Channels 1 and 2 have a button for switching the 1/4" line input to an instrument input. When the button is out, the 1/4" input accepts normal line-level signals from low-impedance sources. When the button is pushed in, the 1/4" input accepts high-impedance signals from instruments with electric pickups, which you would normally run through a DI box.



Plugging a guitar straight into a typical line input can result in the loss of high frequencies, causing an unnatural and dull sound. Normally, you must use a direct box between a guitar and a mixer's or preamplifier's input,

which serves to convert the impedance of the guitar from high to low. The Instrument inputs on channels 1 and 2 make the need for a direct box unnecessary.

HOWEVER: The Instrument inputs *are* unbalanced, so if you are running a long cord between the instrument and the Onyx Satellite (say over 20 feet), it is best to use a direct box with a balanced output to avoid picking up noise over the length of the cord.

4. POWER Indicator

When power is applied to the pod, either through the FireWire connection or with the AC adapter, the POWER LED lights to let you know the unit is operational.

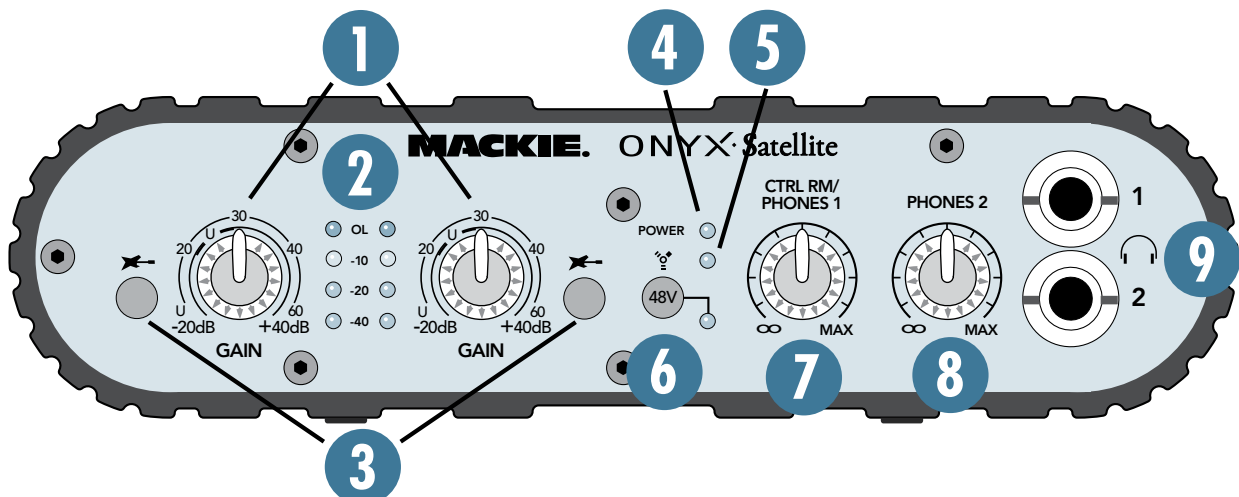

5. FireWire Indicator

This LED illuminates when a valid FireWire connection is made between the Onyx Satellite and a computer.

6. 48V Phantom Power Switch and Indicator

Most professional condenser microphones require phantom power, which is a low-current DC voltage delivered to the microphone on pins 2 and 3 of the XLR microphone connector. Push in the 48V button if your microphone requires phantom power. An LED lights next to the button to indicate that phantom power is active.

This is a global phantom power switch and applies 48V to the XLR input connectors on channels 1 and 2.

Dynamic microphones, like Shure's SM57 and SM58, do not require phantom power. However, phantom power will not harm most dynamic microphones should you accidentally plug one in while the phantom power is turned on. Be careful with older ribbon microphones. Check the manual for your microphone to find out for sure whether or not phantom power can damage it.

7. CTRL RM/PHONES 1 Level

Use this knob to adjust the signal level at the CTRL RM Out [11] jacks on the rear panel of the pod. It also adjusts the signal at the PHONES 1 [9] jack on the front, since they share the same signal. It ranges from off (∞) to maximum gain (MAX).

8. PHONES 2 Level

This knob adjusts the signal level at the PHONES 2 jack [9] on the front panel. It ranges from off (∞) to maximum gain (MAX).

Having independent level control for each headphone output means that in an overdub situation, for example, the musician and the engineer can each adjust their own headphone volume to taste.

9. PHONES 1 and 2 Outputs

This is where you plug in your stereo headphones. These are 1/4" TRS stereo jacks. The same signal appears at both PHONE jacks, but each has its own individual level control [7/8]. The same signal is also routed to the CONTROL ROOM outputs [11], which share the level control with the PHONES 1 output.



WARNING: The headphone amps are designed to drive any standard headphones to a very loud level. We're not kidding! They can cause permanent hearing damage. Even intermediate levels may be painfully loud with some headphones.

BE CAREFUL! Always start with the PHONES level turned all the way down before connecting headphones to the PHONES jack. Keep it down until you've put on the headphones. Then turn it up slowly. Why? Always remember: ***"Engineers who fry their ears, find themselves with short careers."***

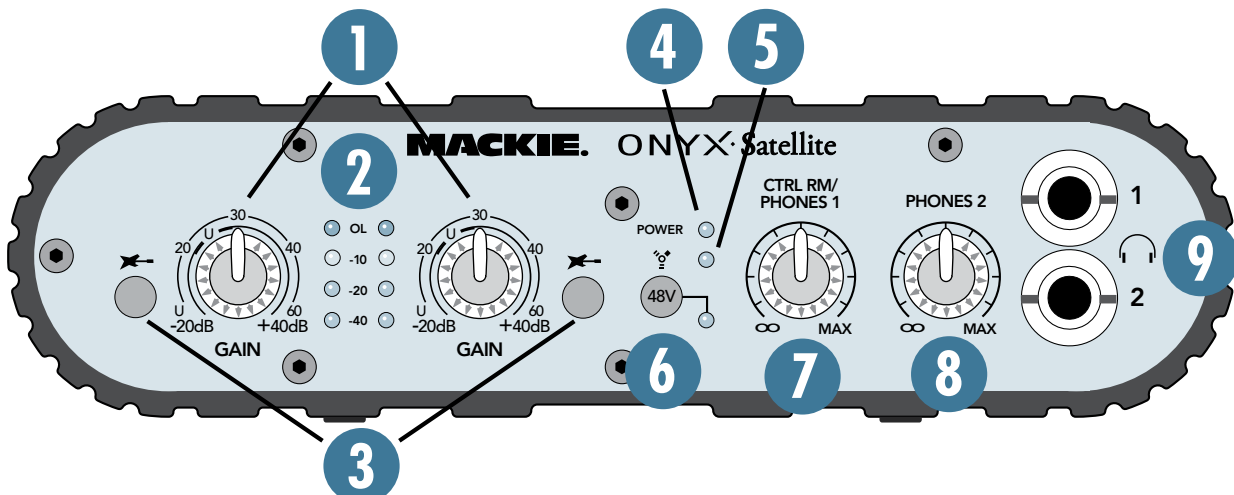

Pod Rear Panel

10. MIC/Line Inputs

These are Neutrik combo connectors, which accept balanced microphone inputs from an XLR connector, or balanced line-level or instrument inputs from a 1/4" TRS connector. The microphone preamps feature our new Onyx design, with higher fidelity and headroom rivaling any standalone mic preamp on the market today.

- The XLR inputs are wired as follows:
- Pin 1 = Shield or ground
 - Pin 2 = Positive (+ or hot)
 - Pin 3 = Negative (- or cold)

The 1/4" inputs are wired as follows and will accept both balanced and unbalanced inputs:

- Sleeve = Shield or ground
- Tip = Positive (+ or hot)
- Ring = Negative (- or cold)

11. CR OUT

These 1/4" TRS jacks provide a balanced or unbalanced line-level signal that can be used to provide a monitor mix to a pair of powered studio monitors, or an additional headphone mix to a headphone amplifier.

The signal at the CR OUTs is the same signal that appears at the PHONES 1 and 2 Out [9].

12. TO DOCK Connector

This multipin connector mates with the base station docking connector and allows the pod and the base station to share their circuits.

13. FIREWIRE

FireWire (a.k.a. IEEE 1394) is a high-speed serial I/O interface for connecting digital devices, with more than 30 times the bandwidth of USB 1.1.

The FireWire interface provides two inputs to your DAW software application (inputs 1-2). The FireWire interface on the pod also provides a return for two channels from the DAW, which can be routed back to the control room/phones outputs to monitor the computer audio through your control room speakers or headphones.

Note: When the pod is docked to the base station, up to six channels can be returned from the DAW for monitoring purposes.

The FireWire interface works with both PC and Mac.



If your laptop or desktop computer does not have a FireWire connection, you can purchase a PCI or PCMCIA FireWire card and install it in your computer easily and inexpensively.

14. POWER Connector

Normally, the Onyx Satellite can be powered from the FireWire connector (which provides 12V DC for powering devices). However, if you are using a 4-pin FireWire connector instead of a 6-pin connector (the 4-pin connector doesn't provide power), or if you have two or more devices daisy-chained on a single connector, you need to use the AC adapter that came with your Onyx Satellite.

Connect the AC adapter to the Onyx Satellite first, then plug the adapter into a suitable and properly rated AC outlet.

15. Kensington Security Slot

To help prevent theft, this security slot is designed to fit the popular Kensington security locks. A variety of models are available from their website at www.kensington.com.

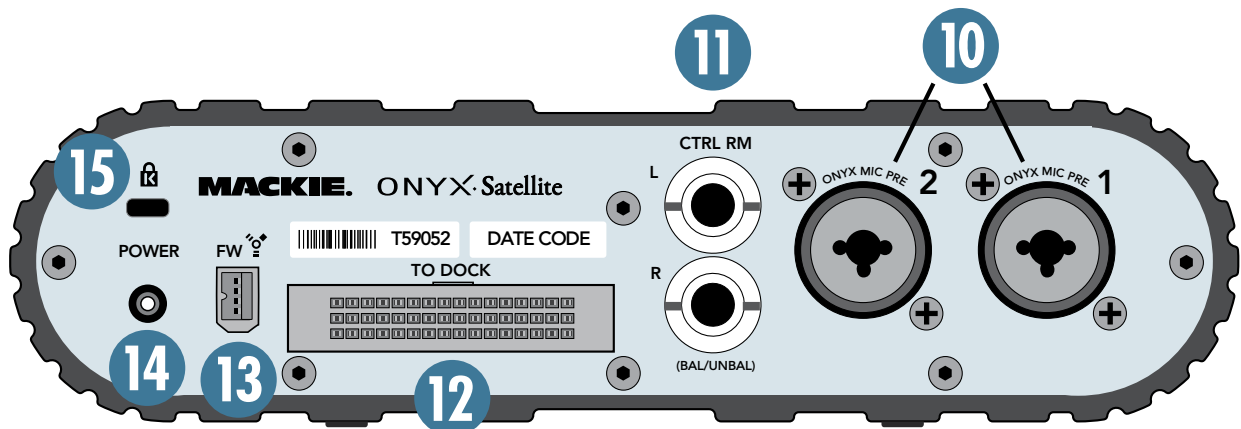

Base Station Front Panel

When the pod is connected to the base station, some additional features become available above and beyond those that are present when using the pod by itself.

- More inputs are available to select for each channel (Mic, Instrument, Line 1, and Line 2)
- An insert jack (send/return) is available for each channel
- An additional stereo control room output is available (A and B)
- Four more line-level outputs are available (for a total of six, including the control room outputs)
- A separate control room level control can operate on just the A/B outputs, or on all six outputs as a master level control
- The control room source can be switched between the Core Audio/ASIO streams 1 and 2 from the DAW software application, and the inputs from the Onyx Satellite
- A built-in Talkback Mic is available for routing to the phones and to the DAW application



Note: The base station does not function when the pod is removed. The pod is the “brains” and the base station simply provides more connections and controls than the pod does by itself.

16. MIC Input Select Switch

Press this button to select the XLR Mic input as the input source for the channel.

17. Instrument Input Select Switch

Press this button to select the Instrument input (✂) as the input source for the channel.

Note: The instrument switch on the pod must also be pushed in to select the instrument input.

18. Line Input 1 Select Switch

Press this button to select LINE 1 as the input source for the channel.

19. Line Input 2 Select Switch

Press this button to select LINE 2 as the input source for the channel.



Note: You can select and combine the Mic, Instrument, Line 1, and Line 2 inputs for each channel from the base station. However, the base station has no provision for matching the impedances or the input level of the combined signals, so it is best only to combine similar signals (for example, line-level signals connected to Input 1 and Input 2), or to select only one input at a time.

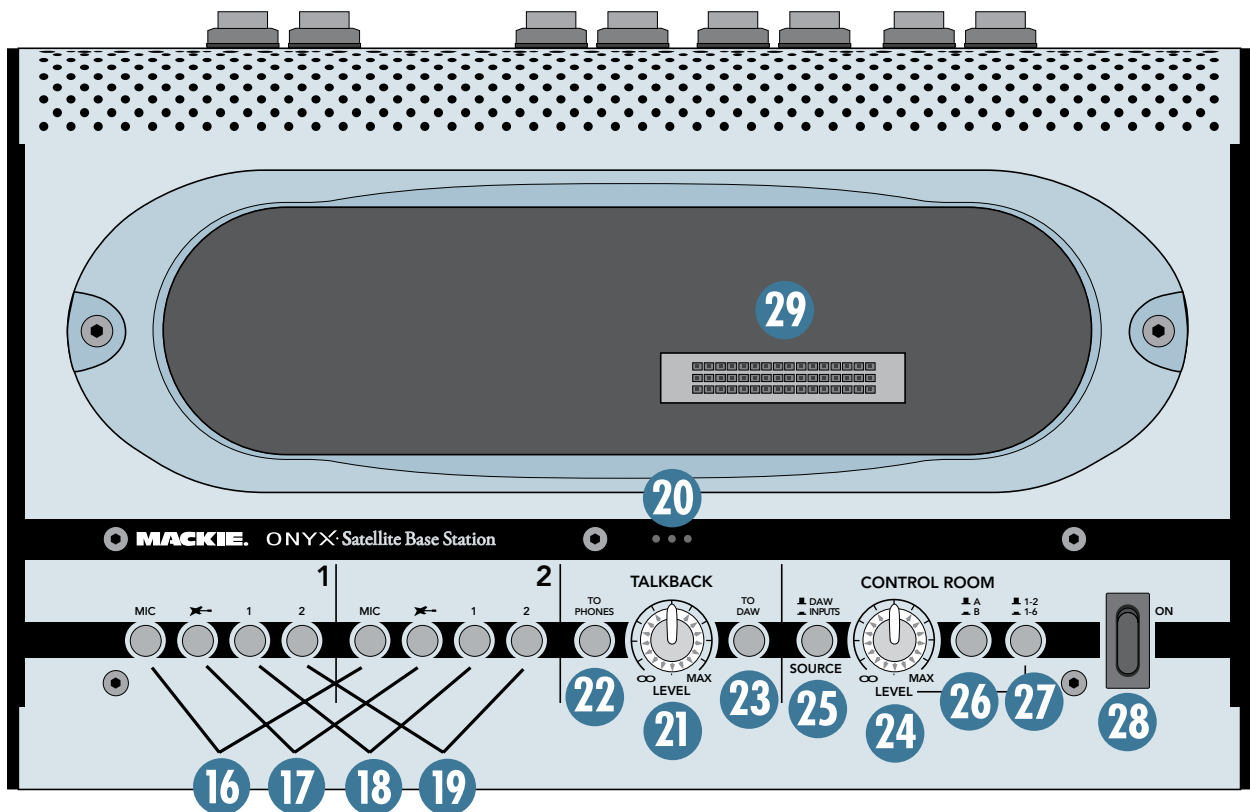

20. Built-in Talkback Mic

This is where the built-in talkback microphone is located. This is an omni-directional dynamic microphone, so it will pick up your voice from anywhere in front of the unit. In addition, the talkback signal is routed through a compressor, which allows the talkback signal to maintain a constant volume regardless of how far you are from the Onyx Satellite (within reason).

21. TALKBACK LEVEL Control

Use this knob to adjust the level of the talkback signal. You should start with the TALKBACK LEVEL control turned down, and then slowly turn it up until you get confirmation from whoever is listening to the headphones that they can hear you. Once you have set the level, you can leave it there for the duration of the session.

If you are using the talkback mic to slate takes in your DAW, use the meters in your DAW to adjust the TALKBACK LEVEL control.

22. TO PHONES Switch

Press this button to route the talkback signal to both PHONES outputs on the pod. This is a momentary switch and is only active as long as you hold the button down. This allows you to talk to the talent without them having to remove their headphones.

23. TO DAW Switch

Press this button to route the talkback signal to channels 1 and 2 being fed to the DAW. This is a mo-

mentary switch and is only active as long as you hold the button down. This allows you to slate takes as you record to the DAW.

Note: When you press either of the Talkback switches, the control room outputs are attenuated momentarily so the engineer can hear himself or herself talk.

24. CONTROL ROOM LEVEL Control

Use this knob to adjust the signal level at the CR OUT [36] jacks on the rear panel. It adjusts the signal for both the left and right Control Room A/B outputs, ranging from off (∞) to maximum gain (MAX).

25. SOURCE Select Switch

Use this switch to select the signal source for the control room outputs. When the switch is up (DAW), the Core Audio/ASIO streams 1 and 2 from the DAW application are routed to the control room outputs. Use this to monitor tracks already recorded and to overdub additional tracks.

When the switch is down (INPUTS), channels 1 and 2 from the Onyx Satellite are routed to the control room outputs. This allows you to listen to whatever is connected to the Onyx Satellite without having a computer connected. Maybe you have a CD player or iPod connected to the Onyx Satellite and you want to listen to it through your control room monitor speakers. Voila! This is particularly useful when you have a home studio setup that does double-duty as a home stereo system.

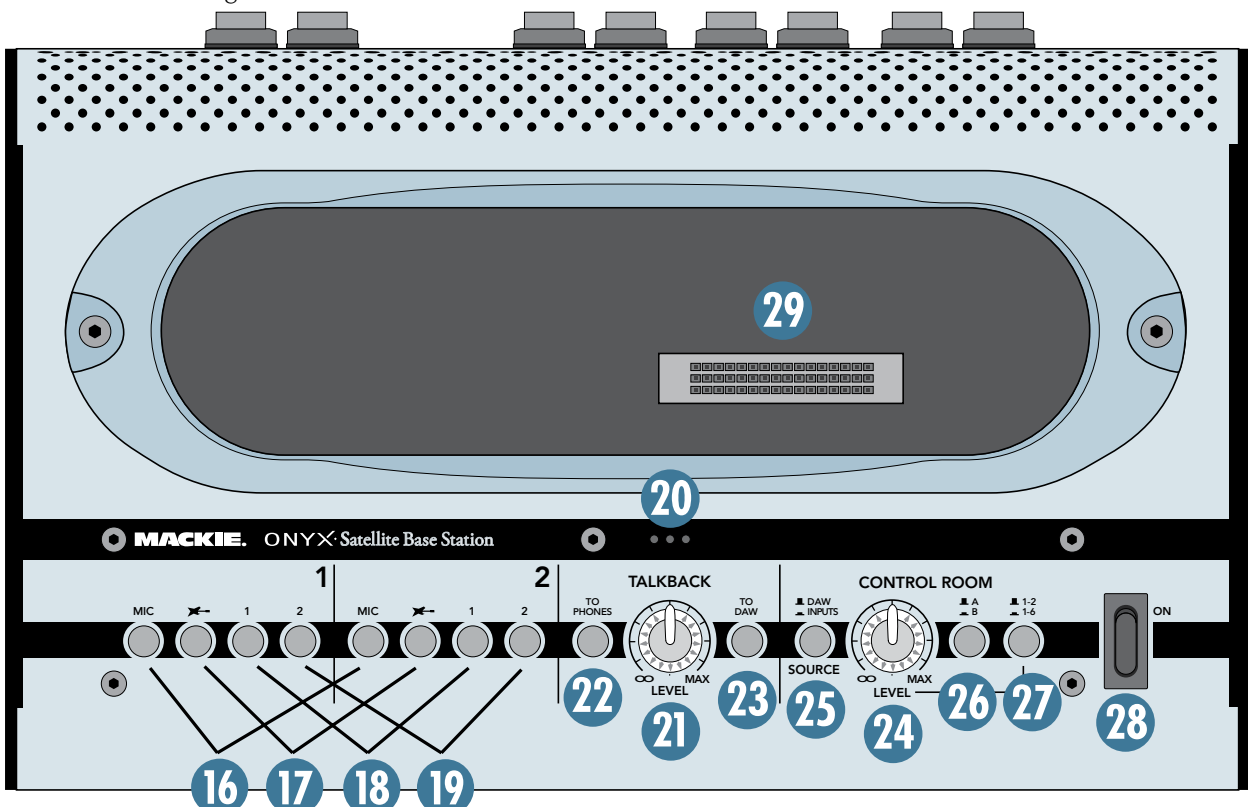

26. A/B Select Switch

This switch determines which pair of control room outputs is currently active. Only one pair of control room outputs provides an output signal at any one time. This allows you to have two sets of monitors connected to the Onyx Satellite so you can make quick A/B comparisons between them to make sure your mix sounds good on both pairs of monitor speakers.

27. 1-2/1-6 Select Switch

When this switch is up (1-2), the CONTROL ROOM LEVEL control [24] adjusts the level at the CR OUTS (1-2) on the rear panel of the base station. When the switch is down (1-6), the CONTROL ROOM LEVEL control adjusts the level at all six outputs. This is useful when mixing in surround sound to provide a master level control for all the surround stems.

Note: When the select switch is up (1-2), outputs 3-6 are not adjustable from the Onyx Satellite, but remain fixed. This is useful for:

- Dialing up some alternate headphone mixes with aux sends from the DAW, and then sending them to the line-level inputs of a headphone amplifier
- Sending a recorded track to an outboard analog processor, like a compressor or EQ
- Transferring a mix to an analog recorder for flavor (like an old reel-to-reel recorder!)

28. Power Switch

This switch turns the power on and off to the Onyx Satellite. When the power switch is on and power is supplied to the Onyx Satellite, either through the FireWire connector or the DC power supply, the POWER LED [4] on the pod lights up.

29. Base Station Dock

The pod plugs into the base station here. Align the “TO DOCK” [12] connector on the pod with the connector in the base station dock and push firmly to insure a secure connection.

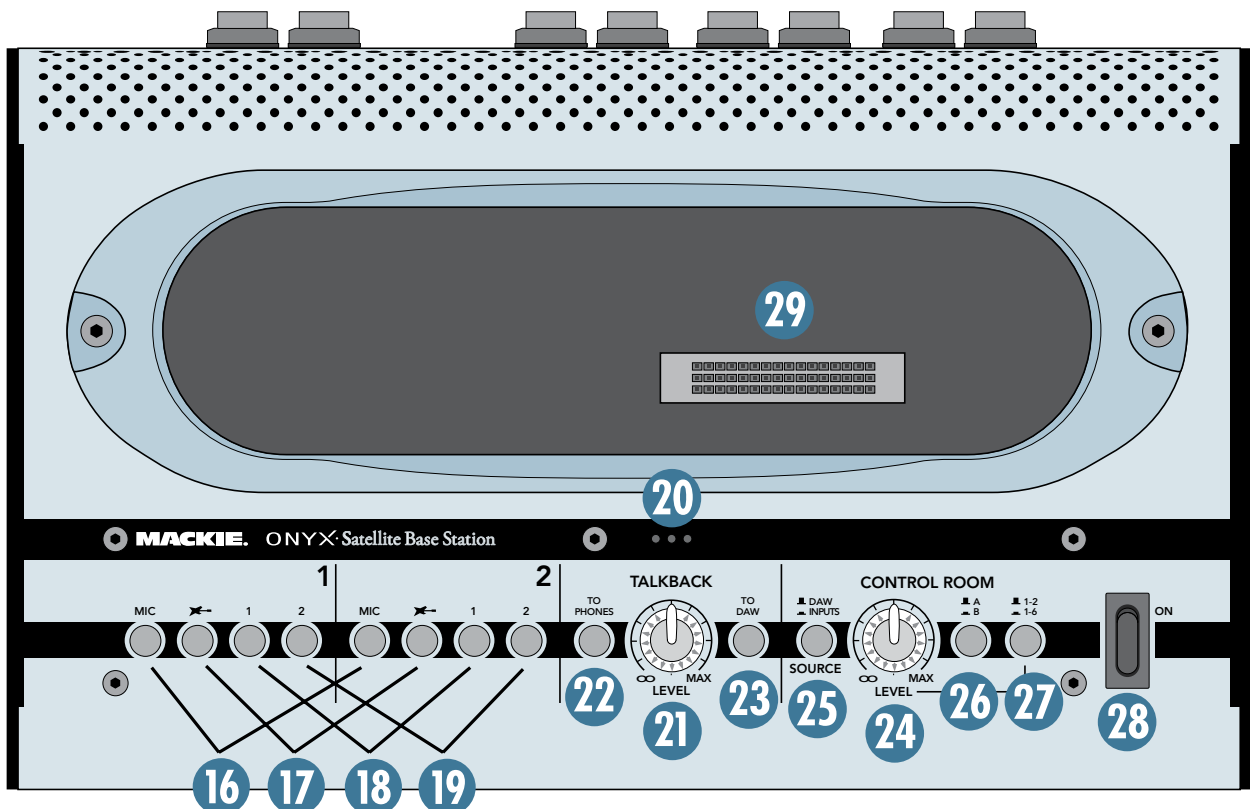

Base Station Rear Panel

30. MIC Input

This is a female XLR connector, which accept balanced microphone inputs from almost any type of microphone. The microphone preamps feature our new Onyx design, with higher fidelity and headroom rivaling any standalone mic preamp on the market today.

- The XLR inputs are wired as follows:
- Pin 1 = Shield or ground
 - Pin 2 = Positive (+ or hot)
 - Pin 3 = Negative (- or cold)

31. LINE 1 Input

This is a 1/4" TRS connector, which accepts a balanced or unbalanced line-level input signal from almost any source.

When connecting a balanced signal to the LINE inputs, wire them as follows:

- Tip = Positive (+ or hot)
- Ring = Negative (- or cold)
- Sleeve = Shield or ground

When connecting an unbalanced signal, wire them as follows:

- Tip = Positive (+ or hot)
- Sleeve = Shield or ground

32. LINE 2 Input

This is a 1/4" TRS connector, which provides a second line-level input for each channel. It works the same as the LINE 1 input.

33. Instrument Input

This is a 1/4" TS connector that accepts an unbalanced instrument-level input signal from a high-impedance instrument like a guitar.

34. INSERT Jacks

These 1/4" TRS jacks provide a send and return point for channels 1-2. Use the INSERT jacks to connect serial effects devices such as compressors, equalizers, de-essers, or filters to each individual channel.

The INSERT points are after the GAIN controls, and just before the analog-to-digital converters. The send (tip) is low-impedance, capable of driving any device. The return (ring) is high-impedance and can be driven by almost any device.



Tip: Since the inserts are before the A/D converters, it's a good place to strap a compressor on an unruly singer to avoid overloading the A/D converter without having to turn down the GAIN control a whole bunch.

Special insert cables are available, specially designed for this kind of insert jack. They are wired as follows:

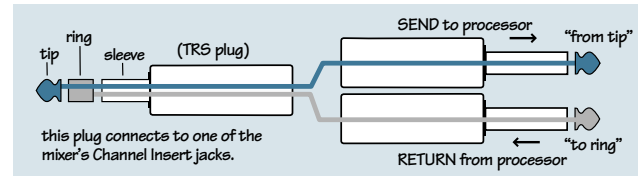

- Tip = Send (output to effects device)
- Ring = Return (input from effects device)
- Sleeve = Common ground (connect shield to all three sleeves)

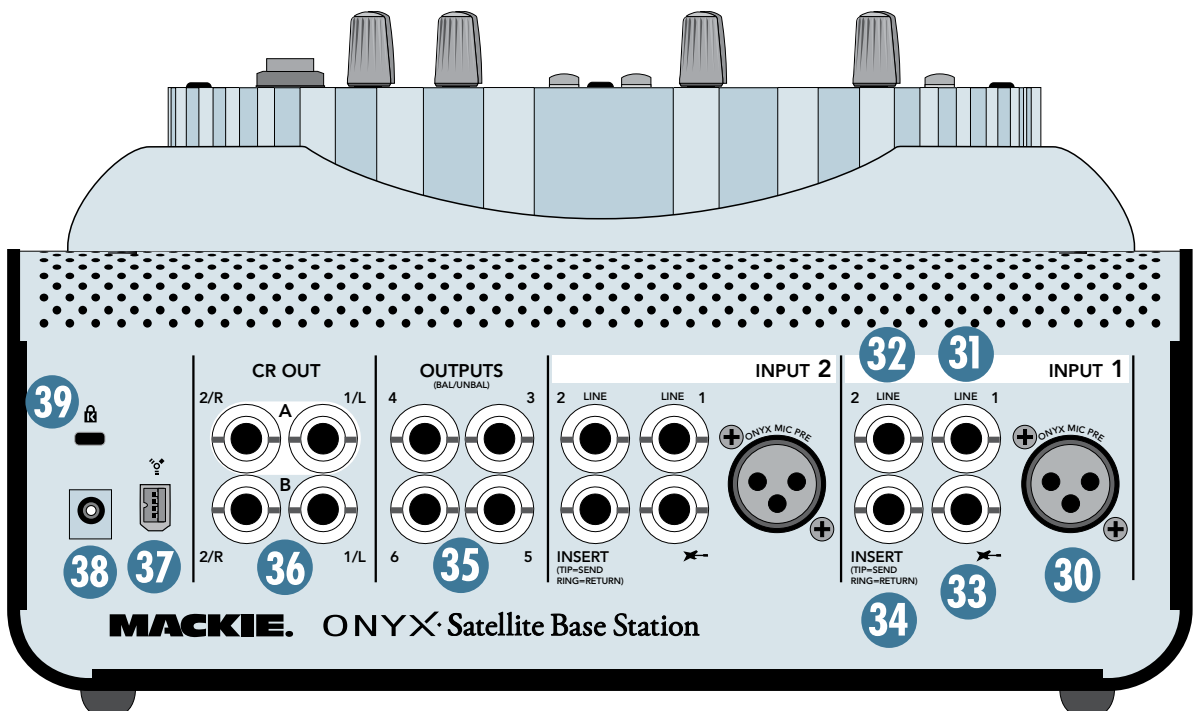

Besides being used for inserting external devices, these jacks can also be used as channel direct outputs (post-GAIN). This is an unbalanced direct out.

Here are three ways you can use the INSERT jacks:

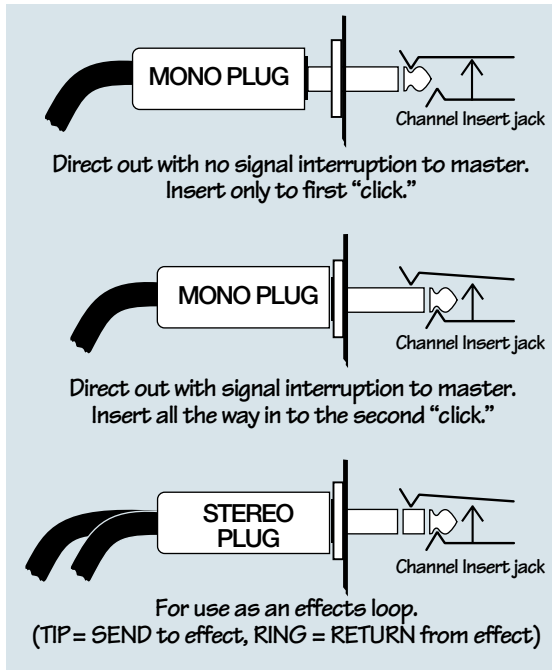

35. OUTPUTS 3-6

These 1/4" TRS output connectors provide balanced or unbalanced line-level analog signals. The signal at the LINE OUTs are assigned in the DAW application as follows:

- Output 3 = Core Audio/ASIO out 3
- Output 4 = Core Audio/ASIO out 4
- Output 5 = Core Audio/ASIO out 5
- Output 6 = Core Audio/ASIO out 6

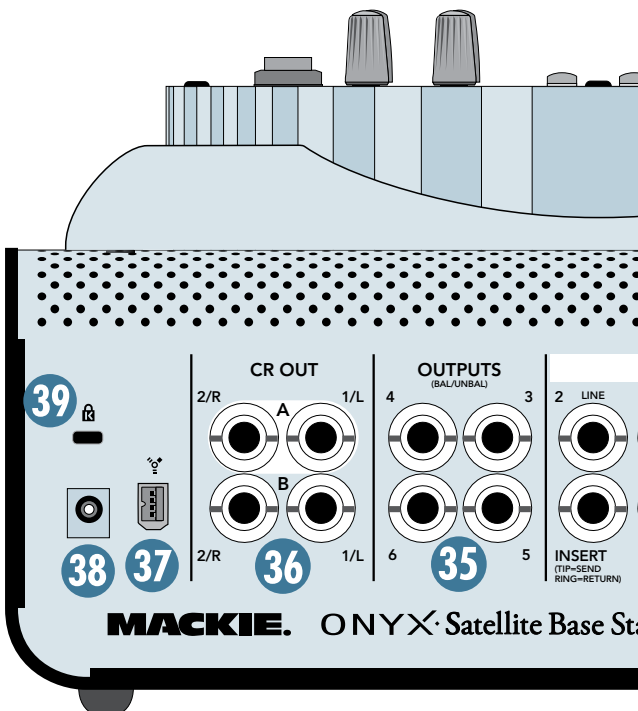

36. CR OUT 1 and 2

These 1/4" TRS jacks provide a balanced line-level signal that can be used to provide a monitor mix to a pair of powered studio monitors, or an additional headphone mix to a headphone amplifier.

There are two pairs of Control Room outputs labeled A and B. These are selected using the A/B Select switch [26] in the Control Room section on the front panel of the base station. The same signal is routed to both stereo control room outputs, as well as the PHONES 1 and 2 outputs.

37. FIREWIRE

When the pod is connected to the base station, the FireWire connector on the base station is activated and used to connect to your computer. It operates in the same way as described for the FireWire connector on the pod [13], except that up to six tracks can be returned from your DAW to the Onyx Satellite instead of just two.

38. POWER Connector

Normally, the Onyx Satellite can be powered from the FireWire connector (which provides 12V DC for powering devices). However, if you are using a 4-pin FireWire connector instead of a 6-pin connector (the 4-pin connector doesn't provide power), or if you have two or more devices daisy-chained on a single connector, you need to use the AC adapter that came with your Onyx Satellite.

Connect the AC adapter to the Onyx Satellite first, then plug the adapter into a suitable and properly rated AC outlet.

39. Kensington Security Slot

To help prevent theft, this security slot is designed to fit the popular Kensington security locks. A variety of models are available from their website at www.kensington.com.

Appendix A: Service Information

Warranty Service

Details concerning Warranty Service are spelled out in the Warranty section on page 35.

If you think your Onyx Satellite has a problem, please do everything you can to confirm it before calling for service. Review the following Troubleshooting section. Visit the Support page on our website (www.mackie.com) and check out the FAQs and the users forums for help.

These may sound obvious to you, but here are some things you can check. Read on.

Troubleshooting

No Power

- If you are using the FireWire connection to power the Onyx Satellite, make sure it is a six-pin connector (the smaller 4-pin connectors do not provide power).
- If you are using the AC adapter, make sure the power cord is securely seated in the POWER socket [14/38] in the pod or the base station, and plugged all the way into the AC outlet.
- Make sure the AC outlet is live (check with a tester or lamp).
- Is the POWER [28] switch on? Make sure the POWER switch on the front panel of the base station is in the ON position (up).
Note: If you are using the pod by itself, it does not have a power switch and is powered up whenever the FireWire or the AC adapter connection is made.
- Is the POWER LED on the pod illuminated? If not, make sure the AC outlet is live (when using the AC adapter) or the FireWire connection is good. Try using another FireWire connection, if available.
- If there are no LEDs illuminated on the front panel, and you are certain that the AC outlet is live (if using the AC adapter) or the FireWire connection is good, it will be necessary to have your Onyx Satellite serviced. *There are no user serviceable parts inside.* Refer to “Repair” at the end of this section to find out how to proceed.

Bad Channel

- Is the input GAIN control [1] for the channel turned up?

- Is the signal source turned up? Make sure the signal level from the selected input source is high enough to light up some of the INPUT meter [2] LEDs for that channel.
- If the pod is docked to the base station, make sure the Input Select switches [16-19] are in the right position.
- If the Instrument Input [17] is selected, make sure the Instrument button [3] is pushed in on the pod.
- Try the same source signal in the other channel, set up exactly like the suspect channel.

Bad Output

- If another output is working correctly, try switching the output connections between the working output and the suspect output. If the working output stops working, it could be a bad cable or the device to which it is connected.

Bad Sound

- Is the input connector plugged completely into the jack?
- Is it loud and distorted? Make sure the input GAIN control [1] for the channel is set correctly. Reduce the signal level on the input source if possible.
- If possible, listen to the signal with headphones plugged into the input source device. If it sounds bad there, it's not the Onyx causing the problem.

Noise/Hum

- Turn down each channel, one by one. If the noise disappears, it's coming from whatever is plugged into that channel.
- Check the signal cables between the input sources and the Onyx. Disconnect them one by one. When the noise goes away, you'll know which input source is causing the problem.

No Audio into your Computer

- Confirm that the Onyx Satellite is receiving mic or line-level input signals (the meters [2] should indicate signal is present).
- Make sure the correct driver is selected in the DAW. In Tracktion, this is selected in the Settings tab under Audio.
- If the Onyx Satellite seems to be working fine and you are using Tracktion, click Restart Device in the Settings tab under Audio. Other DAW applications may have a similar button.

- In Traktion, be sure the correct inputs are selected and the tracks are armed.
- Restart your Onyx Satellite and computer.
- Reinstall the drivers from the CD (PC only).

Glitchy/Distorted Audio into your Computer

- Increase the buffer size. This can be done in the Onyx Satellite Control Panel or in your DAW application.

Repair

Service for Mackie products is available at a factory-authorized service center. Service for Mackie products living outside the United States can be obtained through local dealers or distributors.

If your Onyx Satellite needs service, follow these instructions:

1. Review the preceding troubleshooting suggestions. Please.
2. Call Tech Support at 1-800-898-3211, 7 am to 5 pm PST, to explain the problem and obtain a Service Request Number. Have your Onyx Satellite’s serial number ready.
You must have a Service Request Number before you can obtain factory-authorized service.
3. Keep this owner’s manual and the detachable DC power supply. We don’t need them to repair the Onyx Satellite.

4. Pack the Onyx Satellite in its original package, including endcaps and box. This is **VERY IMPORTANT**. When you call for the Service Request Number, please let Tech Support know if you need new packaging. *Mackie is not responsible for any damage that occurs due to non-factory packaging.*
5. Include a legible note stating your name, shipping address (no P.O. boxes), daytime phone number, Service Request Number, and a detailed description of the problem, including how we can duplicate it.
6. Write the Service Request Number in **BIG PRINT** on top of the box. Units sent without the Service Request Number will be refused.
7. Tech Support will tell you where to ship the Onyx Satellite for repair. We suggest insurance for all forms of cartage.
8. You will need to contact the authorized service center for their latest turn-around times. The Onyx Satellite must be packaged in its original packing box, and must have the Service Request Number on the box. Once it’s repaired, the authorized service center will ship it back, pre-paid (if it was a warranty repair).

Note: Under the terms of the warranty, you must ship or drop-off the unit to an authorized service center. The return ground shipment is covered for those units deemed by us to be under warranty.

Note: You must have a sales receipt from an Authorized Mackie Dealer to qualify for a warranty repair.

Need Help?

**Visit our website at www.mackie.com and click Support.
Check out the FAQs and the users forums
to find answers to your questions.**

**If you still need help, email us at techmail@mackie.com
or you can reach a technical support representative
Monday through Friday
from 7 AM to 5 PM PST at:**

1-800-898-3211



Appendix B: Connections

XLR Connectors

Channels 1-4 accept 3-pin male XLR connectors on the Neutrik combo inputs. They are wired as follows, according to standards specified by the AES (Audio Engineering Society).

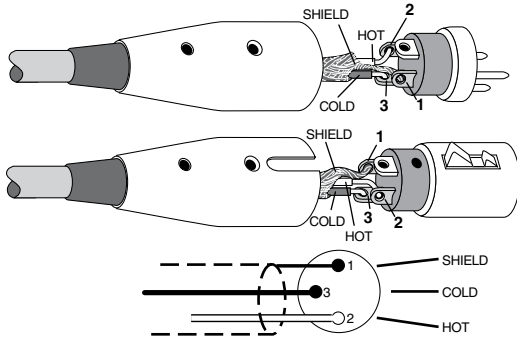

XLR Balanced Wiring:

- Pin 1 = Shield
- Pin 2 = Hot (+)
- Pin 3 = Cold (-)

1/4" TRS Phone Plugs and Jacks

"TRS" stands for Tip-Ring-Sleeve, the three connection points available on a stereo 1/4" or balanced phone jack or plug. TRS jacks and plugs are used for balanced signals and stereo headphones.

Balanced Mono

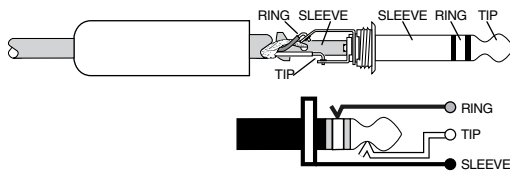

1/4" TRS Balanced Mono Wiring:

- Sleeve = Shield
- Tip = Hot (+)
- Ring = Cold (-)

Stereo Headphones

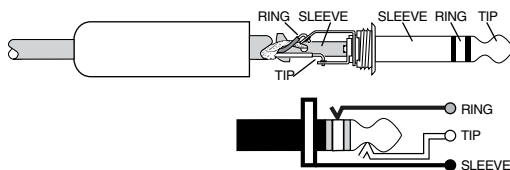

1/4" TRS Stereo Unbalanced Wiring:

- Sleeve = Shield
- Tip = Left
- Ring = Right

1/4" TS Phone Plugs and Jacks

"TS" stands for Tip-Sleeve, the two connection points available on a mono 1/4" phone jack or plug. They are used for unbalanced signals like the high-impedance instrument inputs on the Onyx Satellite.

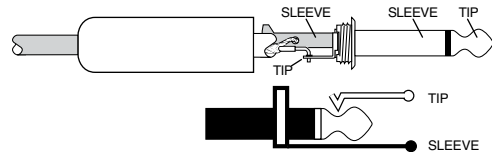

1/4" TS Unbalanced Wiring:

- Sleeve = Shield
- Tip = Hot (+)

RCA Plugs and Jacks

RCA-type plugs (also known as phono plugs) and jacks are often used in home stereo and video equipment, and to make S/PDIF connections on consumer digital audio devices (they are not used on the Onyx Satellite). They are unbalanced and electrically equivalent to a 1/4" TS phone plug.

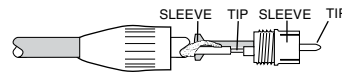

RCA Unbalanced Wiring:

- Sleeve = Shield
- Tip = Hot (+)

Unbalancing a Line

In most studio, stage, and sound reinforcement situations, there is a combination of balanced and unbalanced inputs and outputs on the various pieces of equipment. This usually will not be a problem in making connections.

- When connecting a balanced output to an unbalanced input, be sure the signal high (hot) connections are wired to each other, and that the balanced signal low (cold) goes to the ground (earth) connection at the unbalanced input. In most cases, the balanced ground (earth) will also be connected to the ground (earth) at the unbalanced input. If there are ground-loop problems, this connection may be left disconnected at the balanced end.

- When connecting an unbalanced output to a balanced input, be sure that the signal high (hot) connections are wired to each other. The unbalanced ground (earth) connection should be wired to the low (cold) and the ground (earth) connections of the balanced input. If there are ground-loop problems, try disconnecting the unbalanced ground (earth) connection from the balanced input ground (earth) connection, leaving the unbalanced ground connected to the balanced input low (cold) connection only.

In some cases, you may have to make up special adapters to interconnect your equipment. For example, you may need a balanced XLR female connected to an unbalanced 1/4" TS phone plug. Many common adapters can be found at your local electronics supply store.

TRS Send/Receive Insert Jacks

Mackie's single-jack inserts are three-conductor 1/4" TRS phone jacks. They are unbalanced, but have both the preamp output (send) and input (return) signals in one connector.

The sleeve is the common ground (earth) for both signals. The send from the preamp to the external unit is carried on the tip, and the return from the unit to the preamp is on the ring.

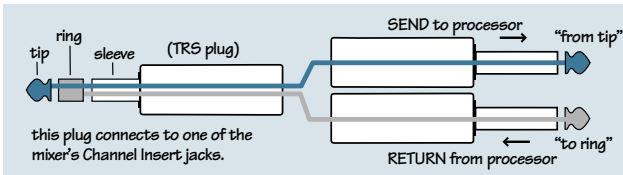

Using the Send Only on an Insert Jack

If you insert a 1/4" TS (mono) plug only partially (to the first click) into a Mackie insert jack, the plug will not activate the jack switch and will not open the insert loop in the circuit (thereby allowing the channel signal to continue on its merry way through the preamp).

This allows you to tap out the channel's signal at that point in the circuit without interrupting normal operation.



Note: Do not overload or short-circuit the signal you are tapping from the preamp. That will affect the internal signal.

If you push the 1/4" TS plug in to the second click, you will open the jack switch and create a direct out, which does interrupt the signal in that channel.

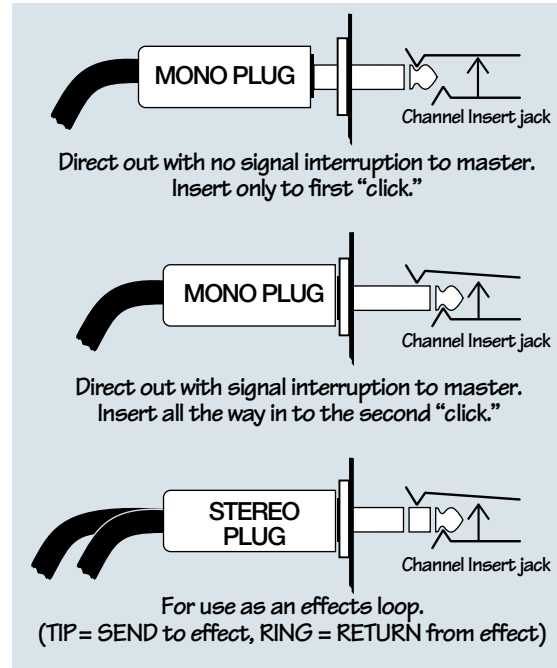

Mults and "Y"s

A mult or "Y" connector allows you to route one output to two or more inputs by simply providing parallel wiring connections. You can make "Y"s and mults for the outputs of both unbalanced and balanced circuits.



Remember: Only mult or "Y" an output into several inputs. If you need to combine several outputs into one input, you must use a mixer, not a mult or a "Y."

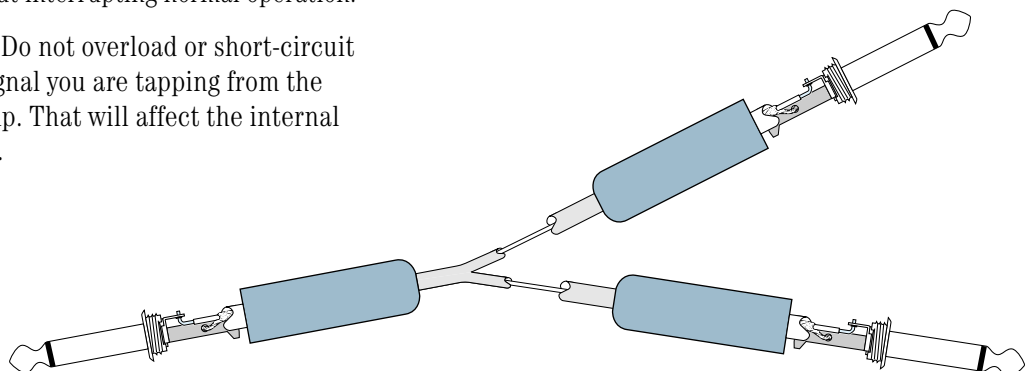

Y-Cord Splitter

FireWire Connection

The Onyx Satellite is equipped with a 6-pin FireWire connector and comes with a 6-pin to 6-pin FireWire cable. This works with Macintosh laptops and desktops, and most PC desktops with a built-in FireWire connector or with a PCI or PCMCIA FireWire card added.

Many laptop PCs have a 4-pin FireWire connector. If this is the case, you will need to use the 6-pin to 4-pin FireWire adapter included with your Onyx Satellite. Remember, the 4-pin connector does not provide power to the Onyx Satellite, so you will need to use the AC adapter to power the unit.

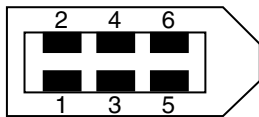

6-pin Male FireWire



4-pin Male FireWire

6-pin FireWire Wiring:

Pin 1 = Power
 Pin 2 = Ground
 Pin 3 = TPB-
 Pin 4 = TPB+
 Pin 5 = TPA-
 Pin 6 = TPA+

4-pin FireWire Wiring:

Pin 1 = TPB-
 Pin 2 = TPB+
 Pin 3 = TPA-
 Pin 4 = TPA+

Appendix C: Technical Info

Onyx Satellite Specifications

Frequency Response

Mic Input to Line Output (Gain @ unity):
 @48 kHz
 20 Hz to 20 kHz, ± 1 dB
 @96 kHz
 20 Hz to 40 kHz, ± 1 dB

Distortion (THD & IMD)

Mic Input to Line Output (@ +4 dBu output):
 THD+N: < 0.02%, 20 Hz to 20 kHz BW,
 1 kHz input @ +4 dBu, preamp at unity gain

Dynamic Range (A-weighted, typical)

103 dB (Mic In to Line Out)

Noise

Signal-to-Noise (A-weighted, typical):
 >103 dB (ref. +0 dBu, Mic In to Line Out, Gain @ unity)
 Equivalent Input Noise (E.I.N.), 20 Hz to 20 kHz Bandwidth,
 150 Ω source impedance, typical:
 -110 dBu @ +60 dB gain

Common Mode Rejection Ratio (CMRR)

Mic In: >40 dB @ 1 kHz, Gain @ maximum, typical

Crosstalk

Mic Input to Line Output:
 < -80 dB @ 1 kHz, +10 dBu signal on adjacent input,
 150 Ω source impedance

Input Gain Control Range

Mic In: 0 dB to +60 dB, ± 1 dB
 Line In: -20 dB to +40 dB, ± 1 dB

Phantom Power

+48 VDC ($\pm 20\%$)

Rated Output

Line: +4 dBu nominal
 Maximum Rated Output:
 +18 dBu @ Balanced Line-Level Outputs

Input Impedance

Mic Input: 2.4 k Ω balanced
 Inst Input: 1 M Ω
 Line: 20 k Ω balanced, 10 k Ω unbalanced

Output Impedance

Line: 100 Ω balanced

Signal Level LEDs

-40 dB, -20 dB, -10 dB (normal operating level),
 OL = 0 dB FS

Sample Frequency Selections

44.1 kHz, 48 kHz, 88.2 kHz, 96 kHz

Analog Input Connectors

Pod:
 Two balanced XLR/TRS combination mic/line inputs
 Base Station:
 Two balanced XLR mic inputs
 Four balanced 1/4" TRS line inputs
 Two 1/4" TS high-impedance instrument inputs

Analog Output Connectors

Pod:
 Two balanced 1/4" TRS line-level outputs
 Base Station:
 Eight balanced 1/4" TRS line-level outputs

Analog Insert Connectors

Base Station:
 Two unbalanced 1/4" TRS line-level inputs/outputs

Digital Input/Output Connectors

Pod:
 One 6-pin FireWire input/output
 Base Station:
 One 6-pin FireWire input/output

Power Requirements

Both units can be powered by the 6-pin FireWire connection or by the DC Power Supply included.
 In the U.S.: 120 VAC/60 Hz In
 12V DC Out
 Outside the U.S.: 100 VAC-240 VAC/50-60 Hz In
 12V DC Out

Physical Dimensions and Weight

Pod
 Height: 2.1 in/53 mm
 Width: 8.0 in/203 mm
 Depth: 4.1 in/104 mm (including front knobs and rear jacks)
 Weight: 1.8 lb/0.8 kg
Base Station
 Height: 4.4 in/112 mm (4.6 in/117 mm with feet)
 Width: 10.8 in/274 mm
 Depth: 7.1 in/180 mm
 Weight: 6.1 lb/2.8 kg

LOUD Technologies Inc. is always striving to improve our products by incorporating new and improved materials, components, and manufacturing methods. Therefore, we reserve the right to change these specifications at any time without notice.

"Mackie.", "Onyx," and the "Running Man" are registered trademarks of LOUD Technologies Inc. All other brand names mentioned are trademarks or registered trademarks of their respective holders, and are hereby acknowledged.

©2006 LOUD Technologies Inc. All Rights Reserved.

Onyx Satellite Dimensions

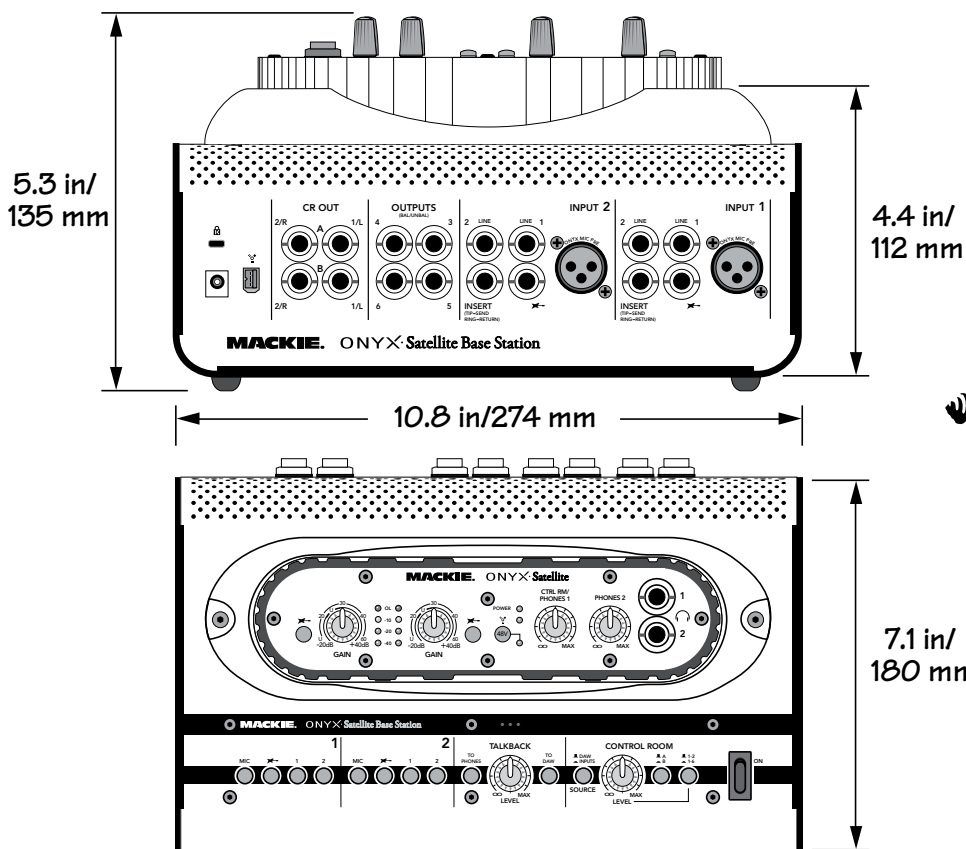
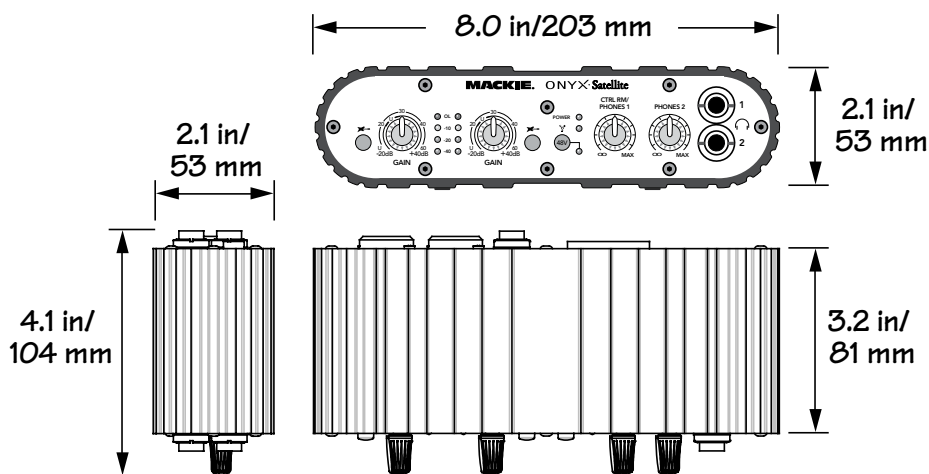

ONYX Satellite Block Diagram

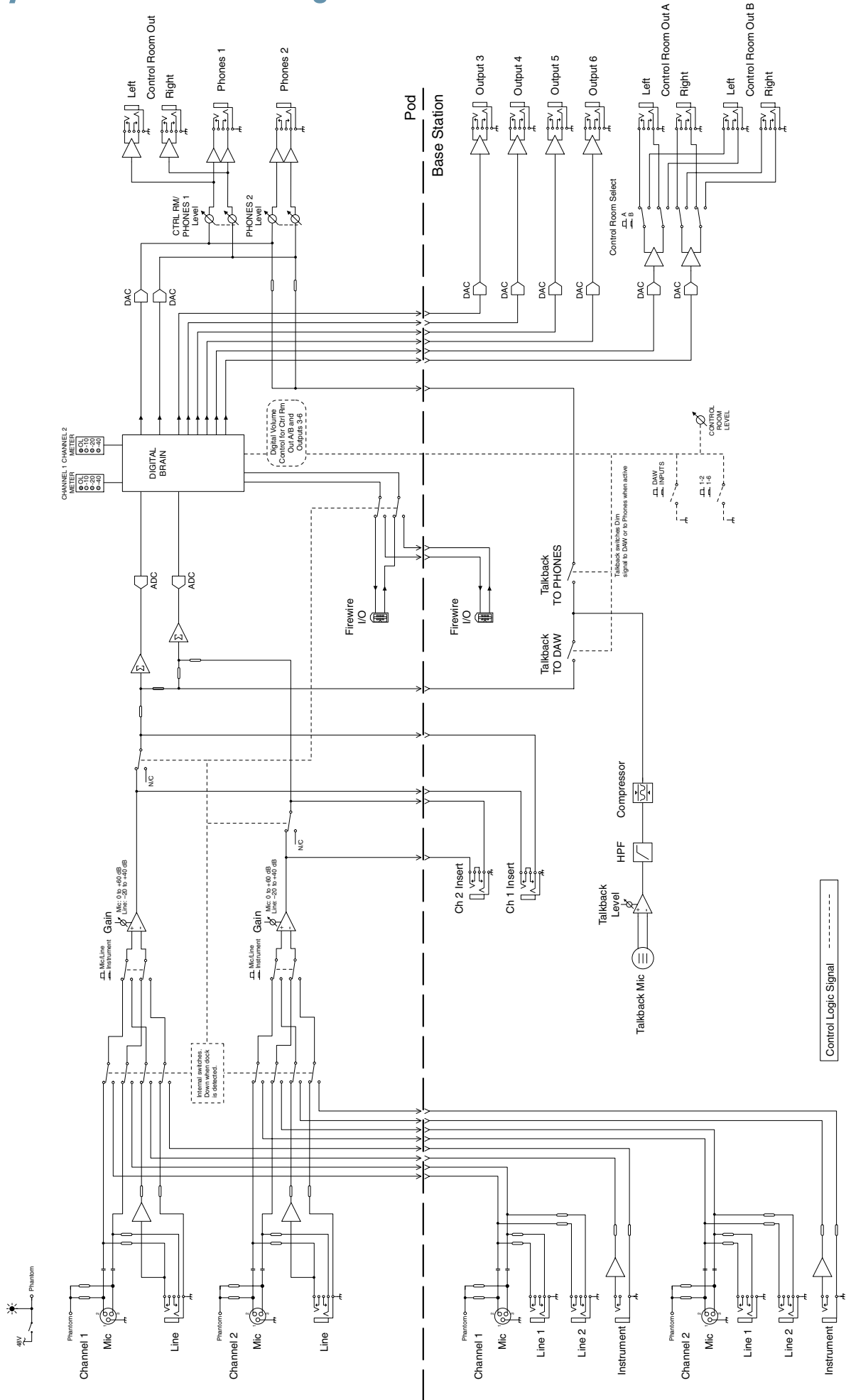

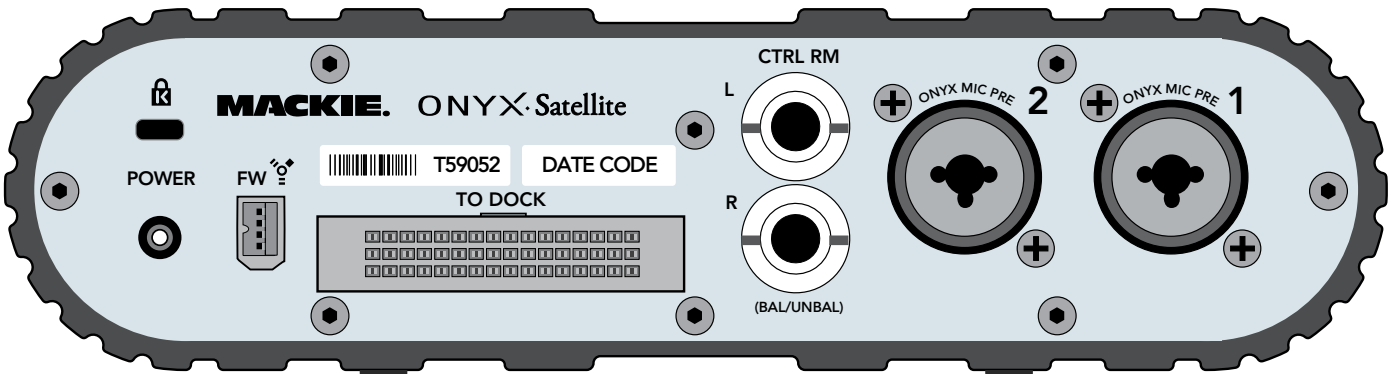
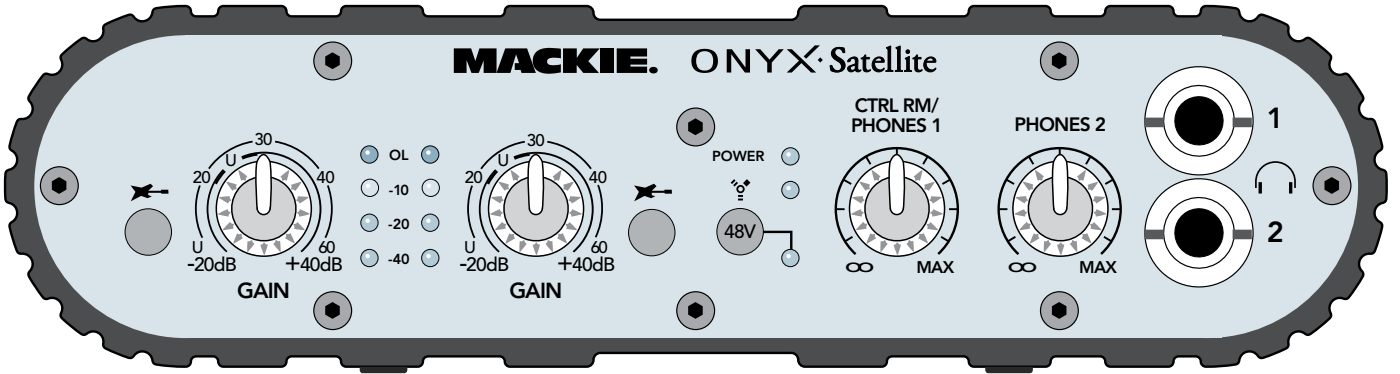

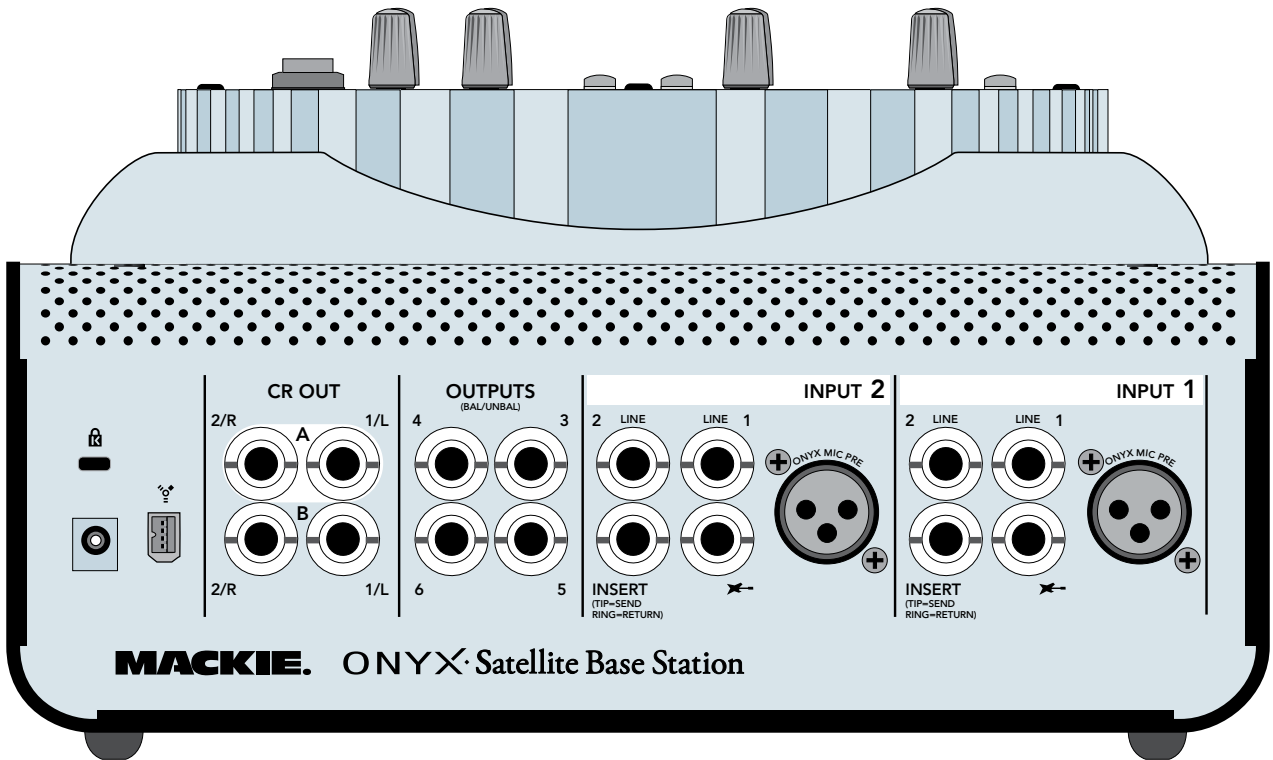
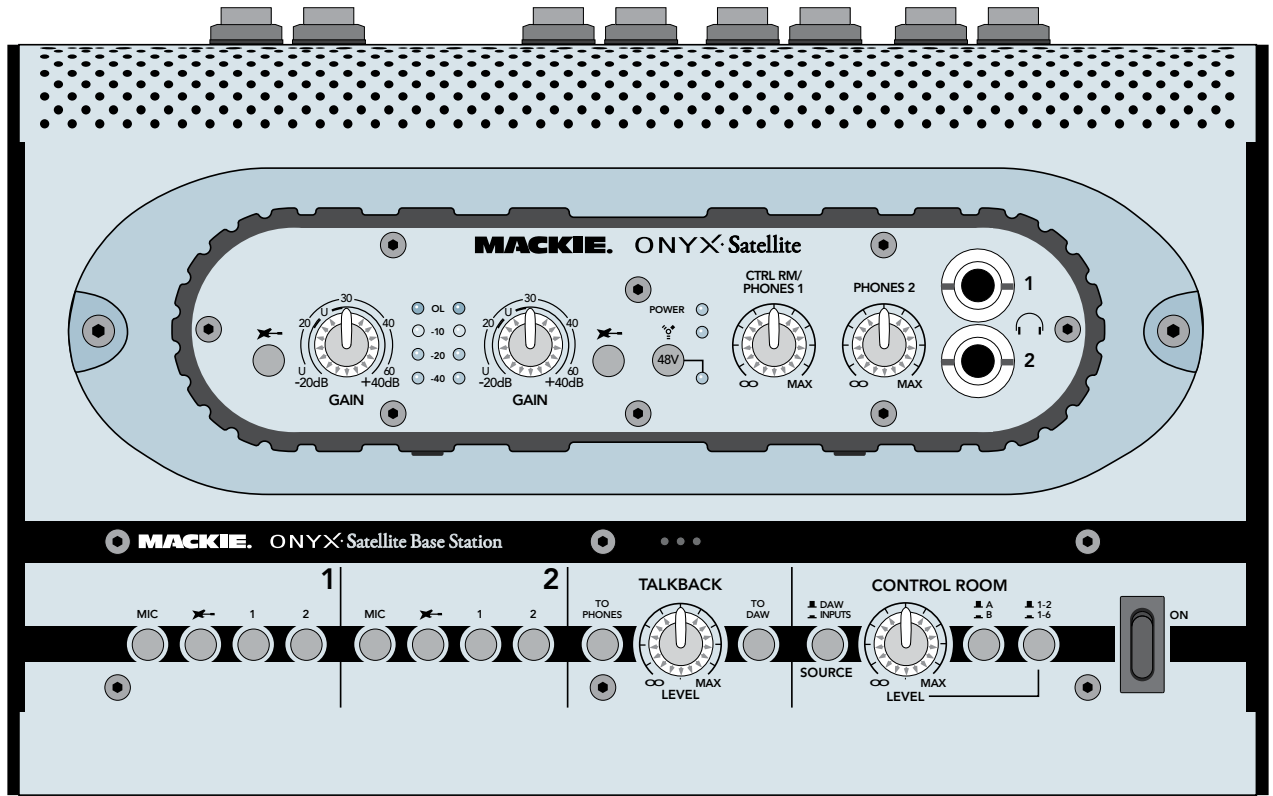

Onyx Satellite Limited Warranty

Please keep your sales receipt in a safe place.

A. LOUD Technologies Inc. warrants all materials, workmanship and proper operation of this product for a period of **one year** from the original date of purchase. If any defects are found in the materials or workmanship or if the product fails to function properly during the applicable warranty period, LOUD Technologies, at its option, will repair or replace the product. **This warranty applies only to equipment sold and delivered within the U.S. by LOUD Technologies Inc. or its authorized dealers.**

B. Failure to register online or return the product registration card will not void the one-year warranty.

C. Service and repairs of Mackie products are to be performed **only** at a factory-authorized facility (see D below). Unauthorized service, repairs, or modification will void this warranty. To obtain repairs under warranty, you must have a copy of your sales receipt from the authorized Mackie dealer where you purchased the product. It is necessary to establish purchase date and determine whether your Mackie product is within the warranty period.

D. To obtain factory-authorized service:

1. Call Mackie Technical Support at 800/898-3211, 7 AM to 5 PM Monday through Friday (Pacific Time) to get a Service Request Number. Products returned without a Service Request Number will be refused.
2. Pack the product in its original shipping carton. Also include a note explaining exactly how to duplicate the problem, a copy of the sales receipt with price and date showing, and your return street address (no P.O. boxes or route numbers, please!). If we cannot duplicate the problem or establish the starting date of your Limited Warranty, we may, at our option, charge for service time.
3. Ship the product in its original shipping carton, **freight prepaid** to the authorized service center. The address of your closest authorized service center will be given to you by Technical Support.

IMPORTANT: Make sure that the Service Request Number is plainly written on the shipping carton.

E. LOUD Technologies reserves the right to inspect any products that may be the subject of any warranty claims before repair or replacement is carried out. LOUD Technologies may, at our option, require proof of the original date of purchase in the form of a dated copy of the original dealer's invoice or sales receipt. Final determination of warranty coverage lies solely with LOUD Technologies.

F. Any products returned to one of the LOUD Technologies factory-authorized service centers and deemed eligible for repair or replacement under the terms of this warranty will be repaired or replaced within thirty days of receipt. LOUD Technologies and its authorized service centers may use refurbished parts for repair or replacement of any product. Products returned to LOUD Technologies that do not meet the terms of this Warranty will not be repaired unless payment is received for labor, materials, return freight, and insurance. Products repaired under warranty will be returned freight prepaid by LOUD Technologies to any location within the boundaries of the USA.

G. LOUD Technologies warrants all repairs performed for 90 days or for the remainder of the warranty period. This warranty does not extend to damage resulting from improper installation, misuse, neglect or abuse, or to exterior appearance. This warranty is recognized only if the inspection seals and serial number on the unit have not been defaced or removed.

H. LOUD Technologies assumes no responsibility for the quality or timeliness of repairs performed by an authorized service center.

I. This warranty is extended to the original purchaser and to anyone who may subsequently purchase this product within the applicable warranty period. A copy of the original sales receipt is required to obtain warranty repairs.

J. This is your sole warranty. LOUD Technologies does not authorize any third party, including any dealer or sales representative, to assume any liability on behalf of LOUD Technologies or to make any warranty for LOUD Technologies Inc.

K. THE WARRANTY GIVEN ON THIS PAGE IS THE SOLE WARRANTY GIVEN BY LOUD TECHNOLOGIES INC. AND IS IN LIEU OF ALL OTHER WARRANTIES, EXPRESS AND IMPLIED, INCLUDING THE WARRANTIES OF MERCHANTABILITY AND FITNESS FOR A PARTICULAR PURPOSE. THE WARRANTY GIVEN ON THIS PAGE SHALL BE STRICTLY LIMITED IN DURATION TO ONE YEAR FROM THE DATE OF ORIGINAL PURCHASE FROM AN AUTHORIZED MACKIE DEALER. UPON EXPIRATION OF THE APPLICABLE WARRANTY PERIOD, LOUD TECHNOLOGIES INC. SHALL HAVE NO FURTHER WARRANTY OBLIGATION OF ANY KIND. LOUD TECHNOLOGIES INC. SHALL NOT BE LIABLE FOR ANY INCIDENTAL, SPECIAL, OR CONSEQUENTIAL DAMAGES THAT MAY RESULT FROM ANY DEFECT IN THE MACKIE PRODUCT OR ANY WARRANTY CLAIM. Some states do not allow exclusion or limitation of incidental, special, or consequential damages or a limitation on how long warranties last, so some of the above limitations and exclusions may not apply to you. This warranty provides specific legal rights and you may have other rights which vary from state to state.

MACKIE®

16220 Wood-Red Road NE • Woodinville, WA 98072 • USA

United States and Canada: 800.898.3211

Europe, Asia, Central and South America: 425.487.4333

Middle East and Africa: 31.20.654.4000

Fax: 425.487.4337 • www.mackie.com

E-mail: sales@mackie.com